



# Shutters



# SPECIFICATIONS



# Shutters - Index

# SPECIFICATIONS

**Shutters Introduction** ..... 1-2

- Quick Glance

**Basswood & Cedar Shutters**..... 3

- Tilt Rod, Louvre Size & Style ..... 4
- Stile options..... 5
- Light stop, Square Frames ..... 6
- L Frames, T-Post ..... 7
- Z Frame, U Channel, Corner Post ..... 8
- Panel Types-Hinged ..... 9-10
- Fixed Shutters ..... 11
- Basswood Plantation Specifications... 12
- Basswood Plantation Construction..... 13
- Basswood Plantation Clearview ..... 14
- Cedar Plantation Specifications ..... 15
- Cedar Plantation Construction ..... 16
- Special Shape Shutters ..... 17
- Hardware Tracking Systems, Hinges.. 18
- Hardware Sliding Single Run ..... 19
- Hardware Multi-fold ..... 20

**Aluminium Shutters** ..... 21

- Tilt Rod, Louvre Size & Style ..... 22
- Light stop, L Frames, T Frames ..... 23
- U Channel, Corner Post, Bay window . 24
- Panel Types-Hinging options ..... 25
- Fixed Shutters ..... 26
- Hardware Tracking Systems, Hinges.. 27
- Hardware Sliding Single Run ..... 28
- Hardware Multi-fold ..... 29

**PVC Shutters**..... 31

- Tilt Rod, Louvre Size & Style ..... 32
- Light stop, L Frames, T Frames ..... 33
- Z Frame, U Channel, Corner Post, Bay window ..... 34
- Panel Types-Hinged, ..... 35-36
- Fixed Shutters ..... 37
- Hardware Tracking Systems, Hinges.. 38
- Hardware Sliding Single Run ..... 39
- Hardware Multi-fold ..... 40

**Motorised Shutters**..... 41

# Shutters - Introduction



## Opening Window:

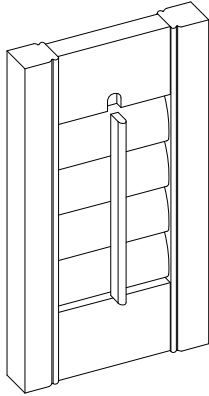

Window Treatments' traditional European styled shutters includes both interior shutters (used on the inside of a house or building) and exterior shutters (used on the outside of a structure). Depending on your application, shutters can be constructed from either Basswood, Cedar, Aluminium or PVC.

Shutters may be used for a variety of reasons: visibility and airflow, including controlling the amount of sunlight that enters a room, to provide privacy, security and to enhance the aesthetics of a building or terrace access adding to the practicality and mood of any interior or exterior.

Shutters can be either fixed permanently in place, hinged, bi-fold or sliding and come with various types of hardware and tracking systems. Depending on your requirements, shutters can be fitted inside or outside of the window opening and can be supplied with various types of frames (Z, L, T, rectangle or square). Shutters can be configured in a single tier unit that has one shutter top to bottom of a window opening as well as multiple tiers. Multiple tier units feature separate shutters on each tier which allows the top shutters to be opened independently from the bottom shutters. Café type shutters refers to shutters

that only cover the lower portion of a window. Full height shutters are made with a horizontal divider (mid-rail) which separates the upper and lower portions of the shutter. With operable louvred shutters this gives greater control as the louvres above the mid-rail can be operated independently from the louvres below the mid-rail.

Window Treatments' shutters consist of a frame of vertical stiles and horizontal rails (top, middle and bottom). Set within this frame, louvres can be adjustable or fixed within the shutter frame. Full height shutters are made with a mid-rail which separates the upper and lower portions of the shutter. A tilt bar is used for adjusting louvre position and to keep the louvres in a uniform position. Alternatively a Clear View metal tilt rod is placed on the reverse side of the shutter allowing for cleaner lines in the front. The Clear View system is commonly used for sliding shutter applications as this decreases light gap measurements and allows each shutter leaf to sit closer to one another.

## Quick Glance

Type		Basswood	Cedar	Aluminium	PVC
<b>Louvres</b>	Louvre Size	47.6mm (aerofoil only), 64mm, 89mm, 114mm (aerofoil & flat blade)	68mm, 90mm	89mm	64mm, 89mm, 114mm
<b>Tilt Bar</b>	Tilt Bar Position Clear View	Centre, Left or Right Yes	Centre, Left or Right Yes	N/A Yes	Centre, Left or Right Yes
<b>Style</b>	Hinged Bi-fold Straight Sliding Fixed Louvres (ventilated) Fixed Louvres (non-ventilated) Special Shape Shutters	Yes Yes Yes Yes Yes Yes	Yes Yes Yes Yes Yes Yes	Yes Yes Yes Yes Yes No	Yes Yes Yes Yes Yes No
<b>Stile Options</b>	Square Rabbet D-mould	Yes Yes Yes	Yes Yes Yes	Yes No Yes	Yes Yes Yes
<b>Motorised Option</b>		Yes	Yes	Yes	Yes
<b>Hardware</b>	Tracking Systems Hardware	Yes Yes	Yes Yes	Yes Yes	Yes Yes
<b>Frame Options</b>	Stiles Mid-rail Light Stop Hang Strips L Frames Z Frames T Post U Channel Corner Post Bay Window Post	Yes Yes Yes Yes Yes Yes Yes Yes Yes Yes	Yes Yes Yes Yes Painted Only Yes Painted Only Painted Only Yes	Yes Yes *Yes - constructed from Basswood No Yes No Yes Yes *Yes - constructed from Basswood *Yes - constructed from Basswood	Yes Yes *Yes - constructed from Basswood *Yes - constructed from Basswood Yes Yes *Yes - constructed from Basswood *Yes - constructed from Basswood *Yes - constructed from Basswood
<b>Finish</b>	Stained Oiled Lacquered Painted  Powder coated	Yes No No Yes, Stnd colours or custom No	No Yes Yes Yes, Stnd colours or custom No	No No No No Yes, Stnd colours only	No No No Yes, Stnd colours or custom No

SPECIFICATIONS

## Material Type

Window Treatments' Shutter range is available in Aluminium, PVC and two types of wood, Basswood and Cedar both of which come from sustainable forests and are renowned as the most durable hardwood and softwood timbers for manufacturing shutters (this is due to their resistance to warping, fine grains, durability and acceptance of a variety of finishes).

Basswood Overview	Cedar Overview
Basswood is a hardwood, durable and lightweight.  The characteristics are a fine straight grain material with an even texture, consistent colour and low resin content.  Basswood has good finishing properties, accepts oil-based paint and exterior stain for longer finishes.	Cedar is an exceptional wood with many characteristics. Cedar is recognized for its natural beauty and physical properties such as its distinguishing aroma, rich colour, durability, insulating properties, workability and acoustics.  Cedar has exceptionally good finishing properties, accepts exterior paint, lacquer and oil. Gives long service with little maintenance and is ideal around moist areas.
Aluminium Overview	PVC Overview
The hard wearing powder coated Aluminium shutter can be used internally, but is particularly suited for external applications. A range of standard colours are available or if requested aluminium shutters can be painted to match any Resene colour from the Resene chart.	PVC shutters look like our wooden shutters but offer a longer life span and a more affordable price tag. Will not absorb moisture, delaminate, split, crack and are excellent for kitchens and bathrooms where moisture may be a problem.

## Finishes

Basswood comes in a range of standard stain and painted colour options or custom colour of your choice. PVC comes in Standard paint colours or can be custom painted. Aluminium is available in standard powder coated colours only. Cedar finishes can be oiled, lacquered or painted. Colour on actual shutters may vary slightly from samples provided, due to natural colour variance in the wood species and paint age.

Finish/Colours	Painted	Stained
<b>Basswood</b>	White-101, Snow-105, Swiss Coffee-107, Creamy-110, Butter-120, Super White-130, Pearl White-131, Egg-shell-132, Pearl-133, Bristle Half-134, Antique White-136, White On White-137, Black-020	Nature-200, Oak-205, Rose-216, Mahogany-220, Black Walnut-230, Desert-252, Ash-253, Gumnut-254, Maple-256, Coffee Bean-258
<b>PVC</b>	White-101, Snow-105, Swiss Coffee-107, Creamy-110, Butter-120, Super White-130, Pearl White-131, Egg-shell-132, Pearl-133, Bristle Half-134, Antique White-136, White On White-137, Black-020 or custom painted to any Colour	N/A
<b>Aluminium - (Powder Coated)</b>	Pearl White-PC-1, Birch-PC-B-2, Black-PC-B-3, Silver-PC-B-4	N/A

Finish/Colours	Lacquered	Oiled	Painted
<b>Cedar</b>	Light to Medium Medium to Dark Natural	Light to Medium Medium to Dark Natural	Colour match to any Resene Colour Chart

## Louvre Size and Tensioning Screw

Various size louvres are available with a choice of two profiles. The first is elliptical in shape, sculptured where the louvre is thicker in the middle and tapered to the front and back. An elliptical louvre is stronger than the alternative traditional flat 68mm louvre. *For technical data, refer to pages 14, 15, 16, 17, 18, 19, 20, 21.*

For Basswood shutters, we have a unique tensioning screw which is used to adjust the tension of the louvres. This comes into its own specifically for full height shutters where adjusting the tensioning screw allows the movement of louvres with ease. *For technical data, refer to page 18.*

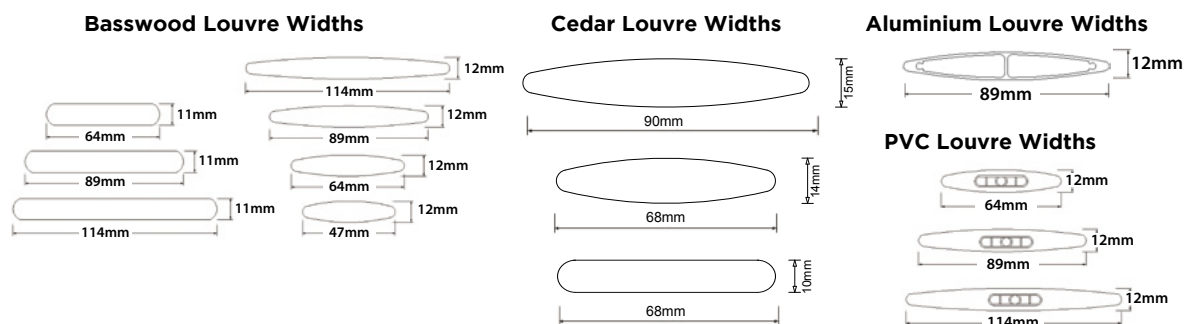

# Basswood & Cedar Shutters

## Introduction

Basswood and Cedar Shutters may be used for a variety of reasons: visibility and airflow, controlling the amount of sunlight that enters a room, privacy, security and the ability to enhance the aesthetics of a building or terrace access adding to practicality and mood of any interior. Window Treatment's traditional European styled Basswood & Cedar shutters are an aesthetically pleasing and versatile window management system. Cedar is recognized for its natural beauty, rich colour, durability, insulating properties and acoustics. Basswood is a hardwood which is durable, lightweight and has a fine straight grain material with an even texture, consistent colour and low resin content. Both Cedar and Basswood have good finishing properties which accept oil based paint and exterior stain for long lasting finishes.

Basswood & Cedar Shutters can be either fixed permanently in place, hinged, bi-fold or sliding depending on your preference and application. Louvres can be adjustable or fixed within the shutter frame. Full height shutters are made with a mid-rail which separates the upper and lower portions of the shutter, with operable louver shutters this gives greater control as the louvres above the mid-rail can be operated independently from the louvres below the mid-rail. A tilt bar is used for adjusting louver position and to keep louvres in uniform position. Alternatively a clear view metal tilt rod is placed on the reverse side of the shutter allowing you to adjust all louvres position by tilting one louver. This also allows for cleaner lines on the front of the shutter and helps to decrease light gap measurements on sliding shutter applications.



## Quick Glance

Type		Basswood	Cedar
Louvres	Louvre Size	47.6mm (Aerofoil only), 64mm, 89mm, 114mm (Flat Blade or Aerofoil)	68mm (Flat blade), 68mm, 90mm (Aerofoil)
Tilt Bar	Tilt Bar Position Clear View	Centre, Left or Right Yes	Centre, Left or Right Yes
Style	Hinged Bi-fold Straight Sliding Fixed Louvres (ventilated) Fixed Louvres (non-ventilated) Special Shape Shutters	Yes Yes Yes Yes Yes Yes	Yes Yes Yes Yes Yes Yes
Stile Options	Square Rabbit D-mould	Yes Yes Yes	Yes Yes Yes
Motorised Option		Yes	Yes
Hardware	Tracking Systems Hardware	Yes Yes	Yes Yes
Frame Options	Stiles Mid-rail Light Stop Hang Strips L Frames Z Frames T Post U Channel Corner Post	Yes Yes Yes Yes Yes Yes Yes Yes Yes	Yes Yes Yes Yes Yes Painted Only Yes Painted Only Painted Only
Finish	Stained Oiled Lacquered Painted Powder coated	Yes No No Yes No	No Yes Yes Yes No

SPECIFICATIONS

# Basswood & Cedar Shutters

## Tilt Rod, Louvre Size, Louvre Style,

### Tilt Rod Control Position:

#### Plantation

Standard position for the tilt bar control on Plantation shutters is centred within the frame. Alternatively, the tilt bar can be positioned off-centred left or right. The off-centred option is mainly used for bi-fold panels to allow the panels to fold onto each other without hitting the tilt bar. A tilt rod (in conjunction with a hooked push pole) is also used for high/out of reach and special shaped shutters.

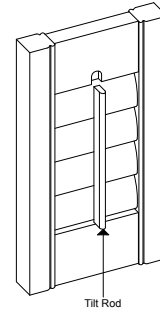

Plantation

#### Clear View

The Clear View control option for Basswood and Cedar shutters is a metal tilt rod rebated into the side of the louvre blade on the reverse side of the panel. This allows for cleaner lines and a clear view through the shutter once the louvres are opened or closed. The standard Clear View tilt bar position is on the hinged stile side of the louvre blades. The Clear View option is also used for sliding shutter applications as this decreases light gap measurements and allows each shutter panel to sit closer to one another reducing the depth of the shutters when stacked.

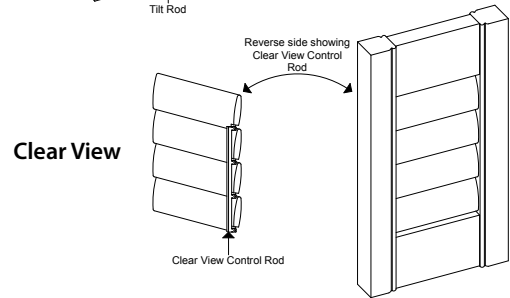

Clear View

### Louvre Size and Tensioning Screw

Various size louvres are available with a choice of two profiles. The first is an aerofoil blade which is elliptical in shape (i.e. thicker in the middle and tapered to the front and back). An aerofoil louvre is stronger than the alternative traditional flat blade 68mm louvre. Note Flat blade is not available in 50mm louvre size.

For Basswood shutters, we have a unique tensioning screw which is used to adjust the tension of the louvres. This comes into its own specifically for full height shutters where adjusting the tensioning screw allows the movement of louvres with ease.

#### Basswood Louvre Widths

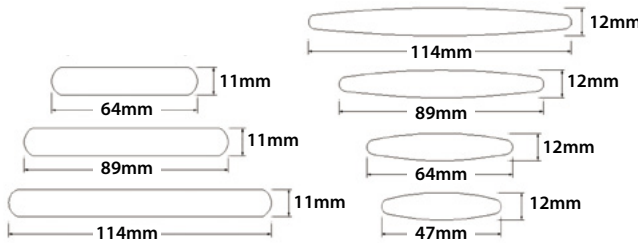

#### Cedar Louvre Widths

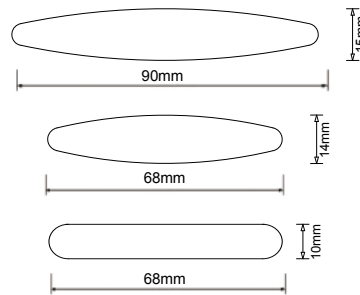

### Louvre Style for Special Shape Shutters

For Basswood and Cedar special shape shutters, Window Treatments supplies 3 louvre style options. Note Flat blade is not available in 50mm louvre size.

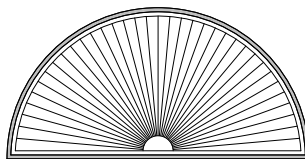

Sector 89mm  
Available louvre - 89mm

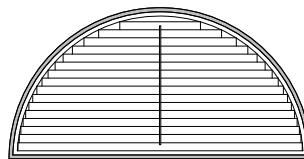

Full Open  
Available louvres - 50, 64, 68, 89, 90mm

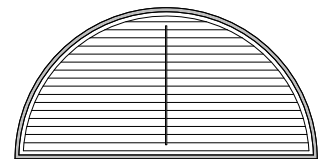

Half Open  
Available louvres - 50, 64, 89mm

Type	Option	Available Louvre Size
Basswood	Sector 89	89mm
	Full Open	50mm, 64mm, 89mm
	Half Open	50mm, 64mm, 89mm

Type	Option	Available Louvre Size
Cedar	Full Open	68mm, 90mm

# Basswood & Cedar Shutters

## - Stile options

### Stiles

Window Treatments supplies 3 stile options: Square, Rabbet, and D-mould. For light gaps, Rabbet or D-mould stiles are used to provide a light block where two panels overlap or interlock.

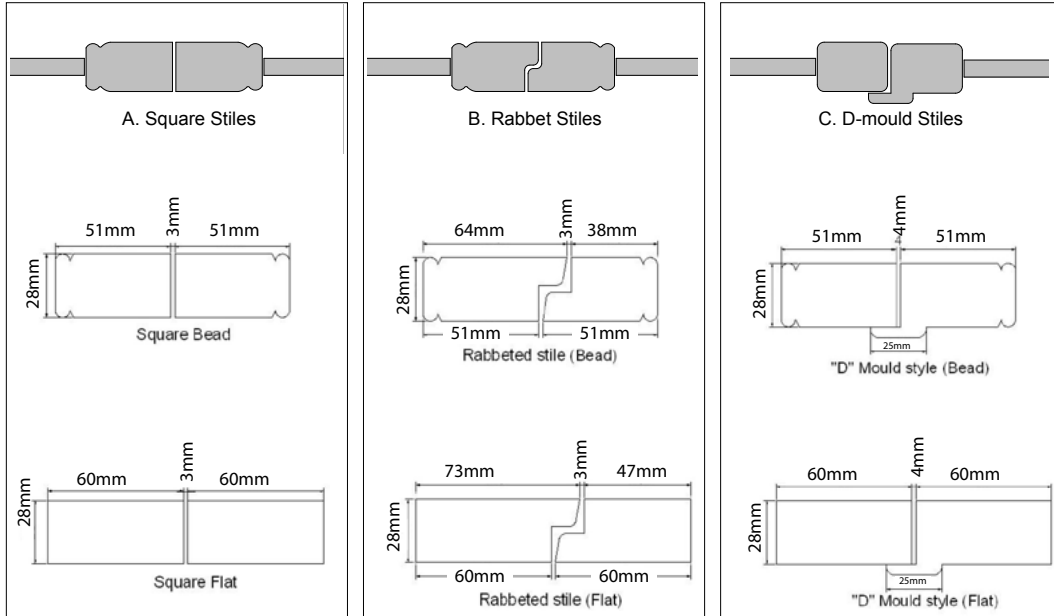

**Please Note:** If there is only one panel then only square stile is available. When the shutter has 2 panels connected with hinges, all stile options are available.

*Square stile (Flat)*



*Square Stile (Bead)*

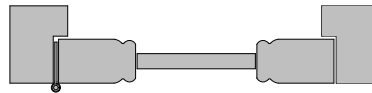

*Square Stiles (Bead)*



*Square & Rabbet Stiles*

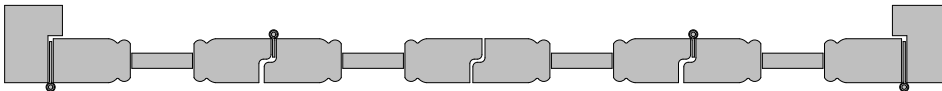

*Square Stile*



*Square & D-mould*



SPECIFICATIONS

# Basswood & Cedar Shutters

- Light stop & Mount types, Square frames & Mount types

SPECIFICATIONS

## Light Stop

Shutter Type	Type	Frame Options	Benefit
Basswood or Cedar	Light Stop	A4, A9,	Provides a light block where panels are hinged.

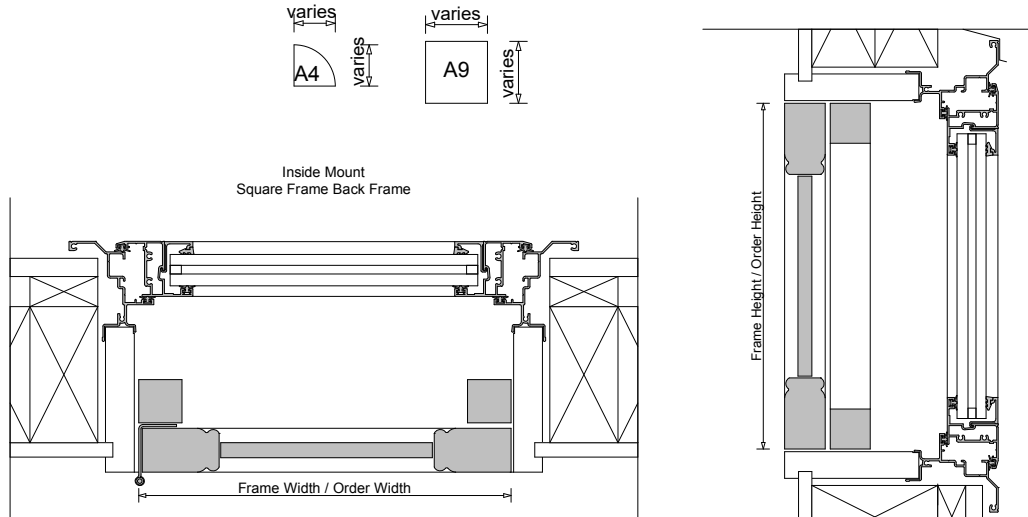

## Square Frame

Shutter Type	Type	Frame Options	Benefit
Basswood or Cedar	Square Frame	B1-1 Standard, B2-1 Beaded	2 Style options are available: Standard and Beaded. Our Standard square frame is best suited to an outside mount application. Our Beaded square frame is best suited to an inside mount application. Using our Standard square frame with a Steadman hinge allows you to protrude the panel past the window opening, giving the ability to hang the shutter panel square in the frame.

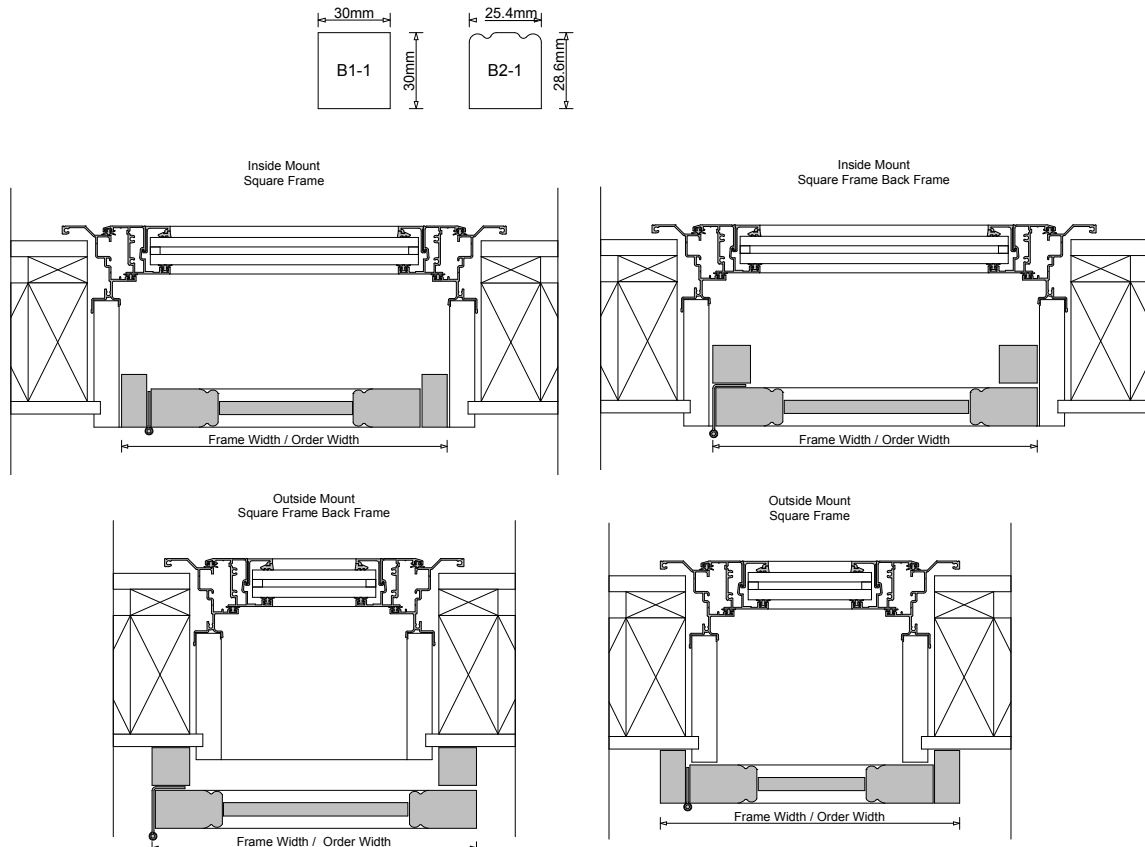



# Basswood & Cedar Shutters

## L Frames & Mount types, T-Posts & Mount types

### L Frame

Shutter Type	Type	Frame Options	Benefit
Basswood or Cedar	L Frame	Standard, Beaded, Pre-drilled	L Frames are used to provide hanging options for single and multiple panels for outside and inside mount applications using a Butt or Steadman hinge. Using Standard and Beaded L Frames with a Steadman hinge allows you to protrude panel past window opening. This gives you the ability to hang the shutter panel square in the frame and closes light gap for flush mounted hinges. Ideal when there is no architrave in the opening.

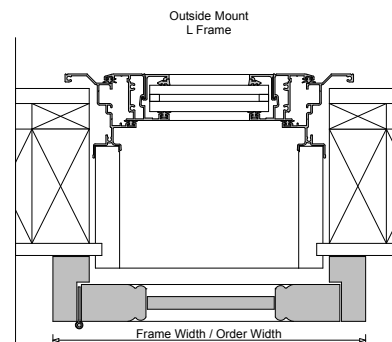
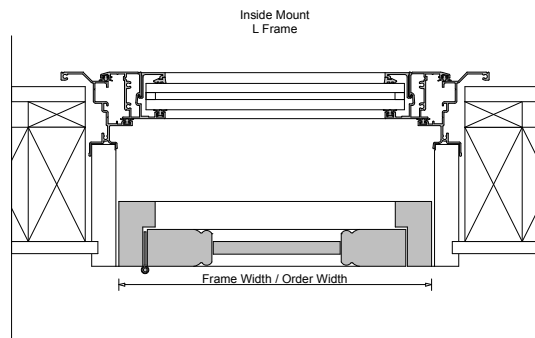
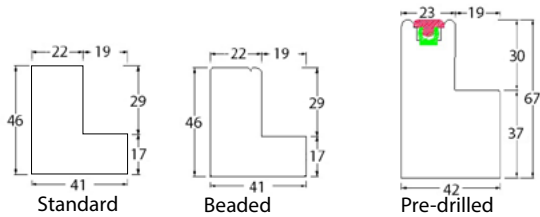

### T Post

Shutter Type	Type	Frame Options	Benefit
Basswood or Cedar	T Post	T1-1 Standard (wide), T2-1 Beaded (wide), Standard (narrow), Beaded (narrow)	T Posts are used to provide hanging options for single and multiple panels for outside and inside mount applications using a Butt hinge. They give you the ability to hang the shutter panel square in the frame. The T Post closes the light gap for flush mounted hinges. Ideal when there is no architrave in the opening.

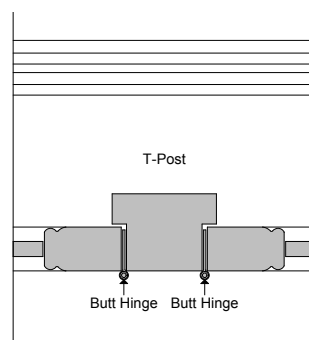
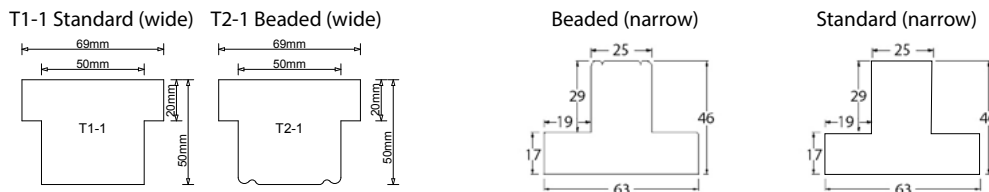

SPECIFICATIONS

# Basswood & Cedar Shutters

## Z Frames, U Channel, Corner Post & Mount types

SPECIFICATIONS

### Z Frame

Shutter Type	Type	Frame Options	Benefit
Basswood or Cedar	Z Frame	Standard (short lipped) Standard (plain) Colonial (Basswood only)	Z Frames are used to provide hanging options for single and multiple panels within an opening. Plumbing the window frame closes the light gap for flush mounted hinges. The Z frame wraps around the reveal edge, making it ideal for covering out-of-square windows. 2 style options are available: Standard or Colonial.

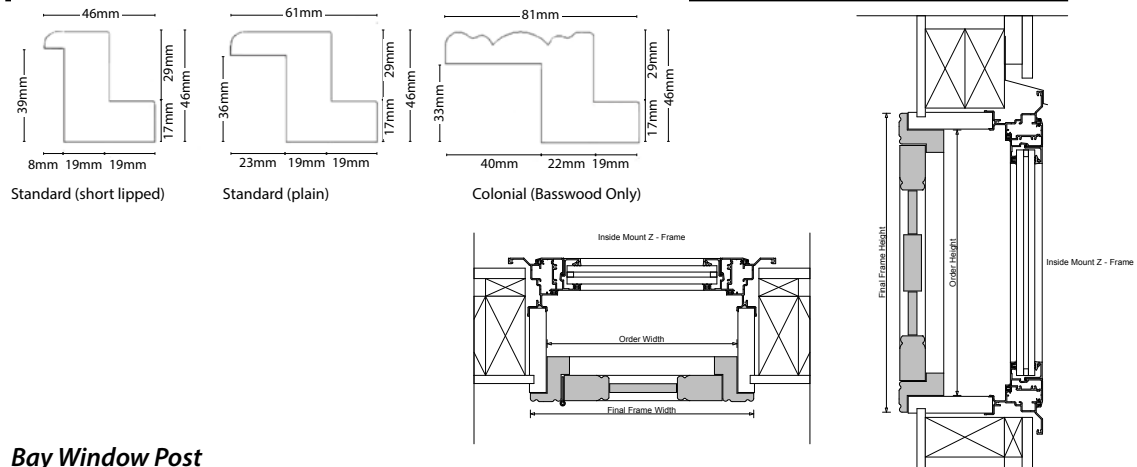

### Bay Window Post

Shutter Type	Type	Frame Options	Benefit
Basswood or Cedar	Bay Window Post	Bay Window Post	Bay Corner Posts are used to provide hanging options for single and multiple panels within a bay window application. Closes light gap for flush mounted hinges. Bay Window Posts are manufactured according to the size required for each installation.

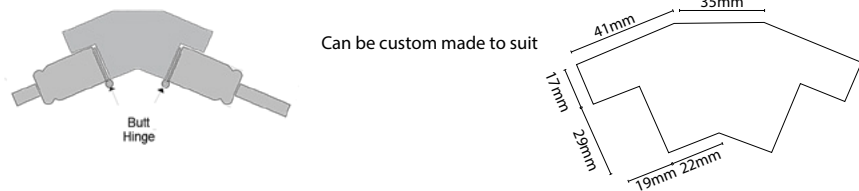

### U Channel

Shutter Type	Type	Frame Options	Benefit
Basswood or Cedar	U Channel	Top, Bottom	Top and bottom 'U Channels' are ideal for incline roof applications or when access to windows is not required. The louvres can open and close and the panel can easily be removed by lifting the shutter up into the top channel and out at the bottom. To refit the reverse applies.

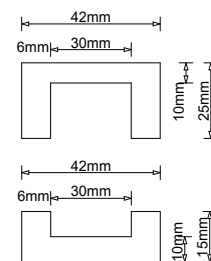

### Corner Post

Shutter Type	Type	Frame Options	Benefit
Basswood or Cedar	Corner Post	CO-PO	Corner Posts are used to provide hanging options for single and multiple panels within a corner application. Closes light gap for flush mounted hinges. Corner Posts are manufactured according to the size required for each installation.

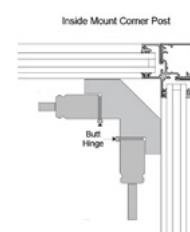
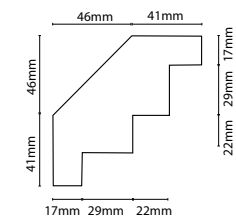

# Basswood & Cedar Shutters

## Panel types - Hinged, L Frame & T Post Hinged

### Panel Types

Panel Types refers to the variations of each type of shutter: single panel fixed, single panel hinged, bi-folds, L Frame and T Post, straight sliding and bi-fold track variations.

The type of hinge used for a single panel, bi-fold, L Frame and T Post and for Rabbet stiles applications is a Butt hinge. However, if you require your panel to protrude past the window opening, a Steadman hinge is required hinged from a hang strip.

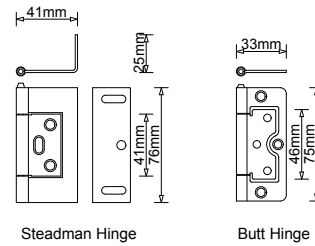

### Hinged

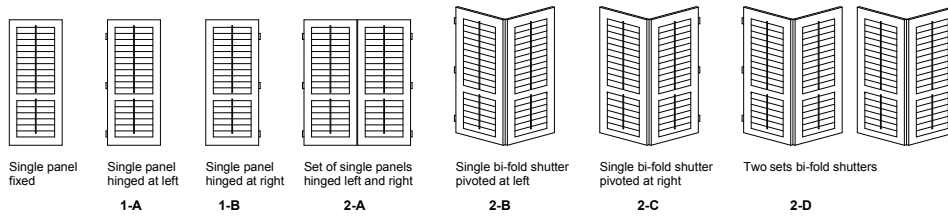

### L Frame and T Post Hinged

When tracks are not feasible, L Frame and T Posts are used to provide hanging options for single and multiple panels within an opening or outside the opening window.

#### Basswood & Cedar (L Frame)

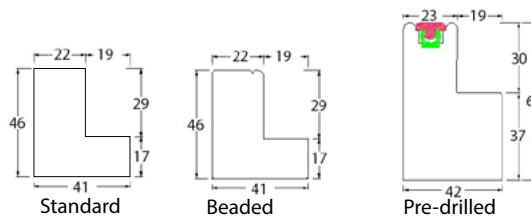

#### Basswood & Cedar (T Post)

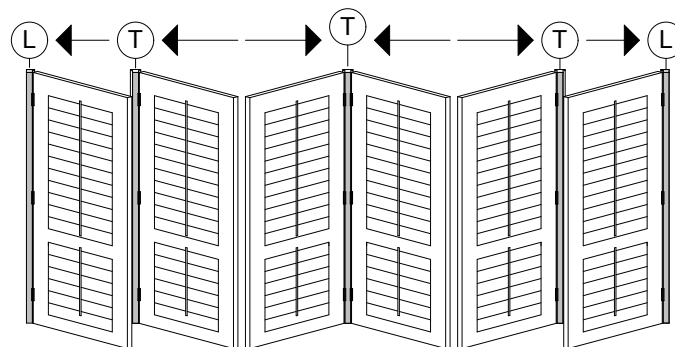
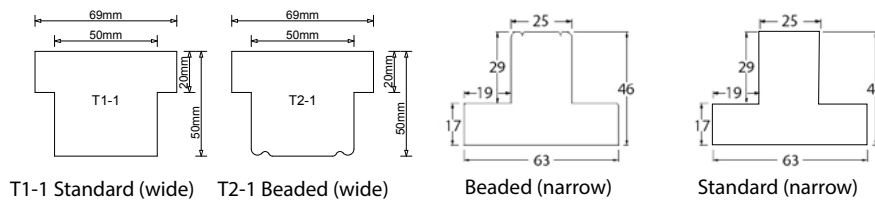

L Frame & T Post hinge options

SPECIFICATIONS

# Basswood & Cedar Shutters

## Panel types - Hinged, L Frame & T Post Hinged - Contd.

### L Frame and T Post Hinged - cont.

#### Key

T means	Panel is hinged from a T Post or closes onto a T Post
L means	Panel is hinged from a L Frame or closes onto a L Frame
→ means	Panel direction to the right
← means	Panel direction to the left

#### One Panel

##### Variations:



#### Two Panel - Individually Hinged

##### Variations:

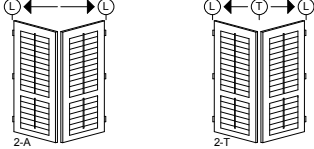

#### Two Panel - Bi-fold

##### Variations:

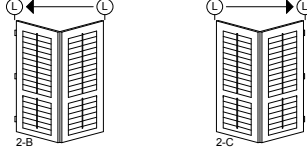

#### Three Panel - Individually Hinged

##### Variations:

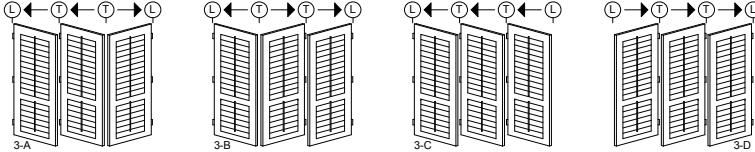

#### Three Panel - Bi-fold

##### Variations:

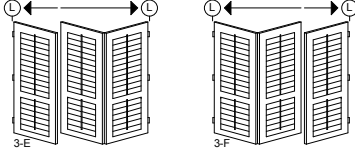

#### Four Panel - Individually Hinged

##### Variations:

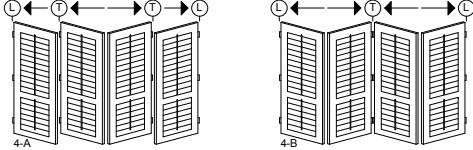

#### Four Panel - Bi-fold

##### Variations:

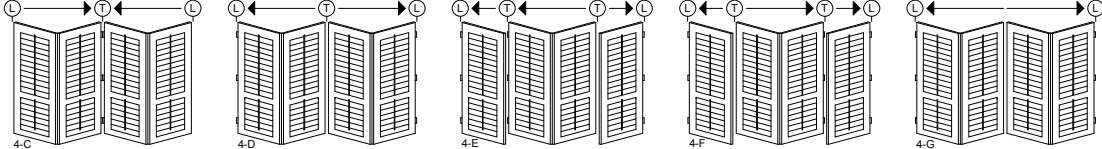

#### Six Panel - Individually Hinged

##### Variations:

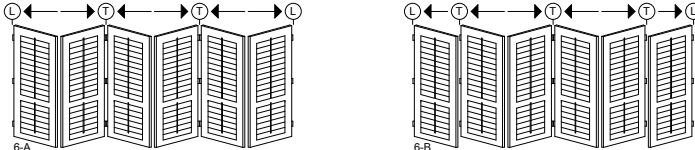

#### Six Panel - Bi-fold

##### Variations:

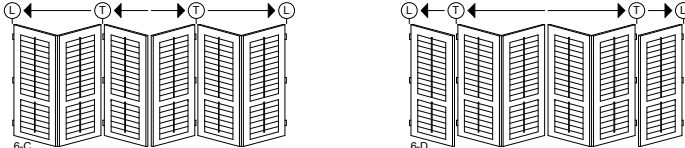

SPECIFICATIONS

# Basswood & Cedar Shutters

## Fixed Shutters

### Fixed Shutters

Fixed louvres are permanently open (ventilated) or permanently shut (non-ventilated). Permanently open means that there is always ventilation while blocking line of sight. Fixed louvres may be employed for a variety of reasons: to control the amount of sunlight that enters a room, to provide privacy and security, protect against weather, unwanted intrusion or damage and to enhance the aesthetics of a building.

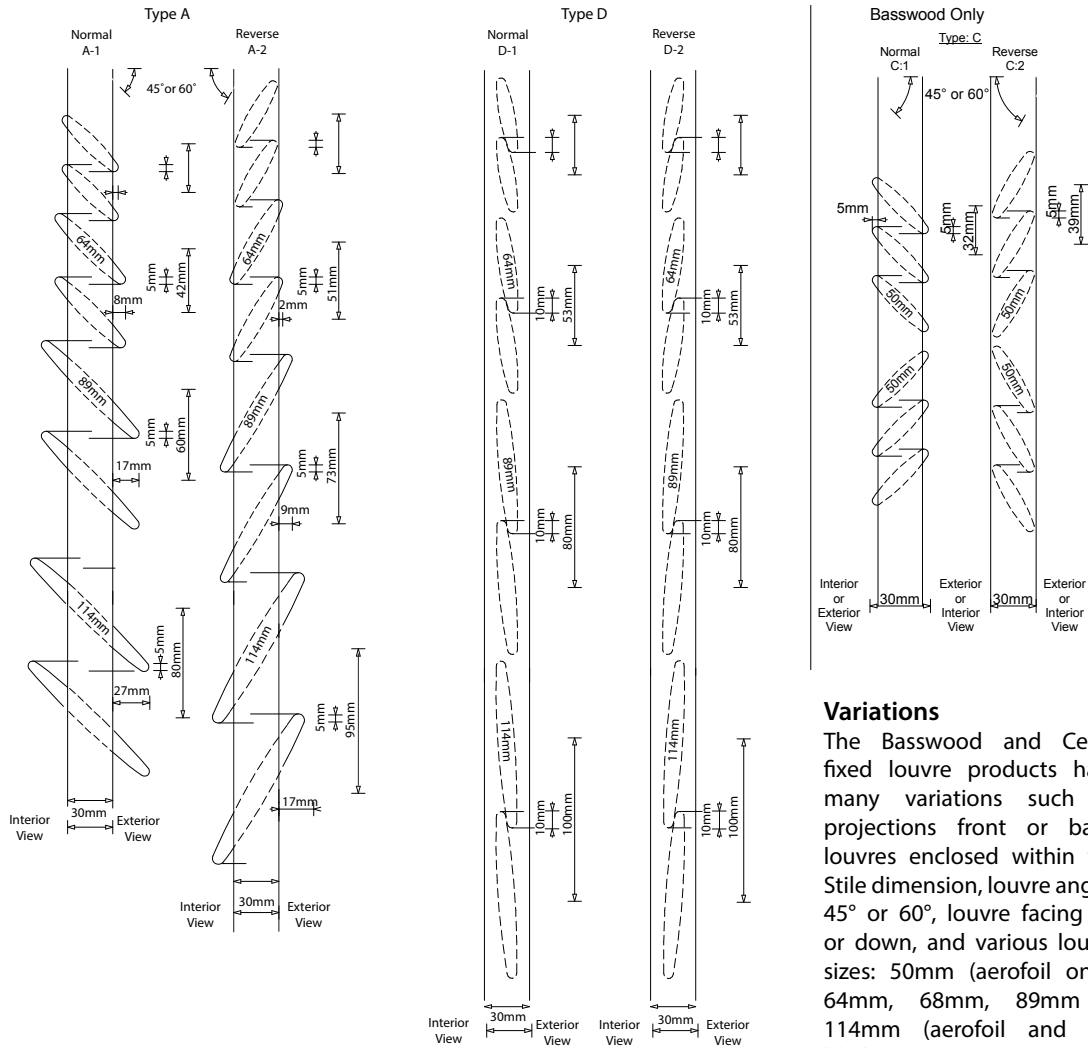

### Variations

The Basswood and Cedar fixed louvre products have many variations such as projections front or back, louvres enclosed within the Stile dimension, louvre angles 45° or 60°, louvre facing up or down, and various louvre sizes: 50mm (aerofoil only), 64mm, 68mm, 89mm & 114mm (aerofoil and flat blade).

	Type A		Type C		Type D	
	Normal A-1	Reverse A-2	Normal C-1	Reverse C-2	Normal D-1	Reverse D-2
Stile (Basswood)	50 x 30mm	50 x 30mm	50 x 30mm	50 x 30mm	50 x 30mm	50 x 30mm
Stile (Cedar)	60 x 30mm	60 x 30mm			60 x 30mm	60 x 30mm
Louvres (Basswood) Aerofoil	50, 64, 89, 114mm	50, 64, 89, 114mm	50mm	50mm	50, 64, 89, 114mm	50, 64, 89, 114mm
Louvres (Basswood) Flat Blade	64, 89, 114mm	64, 89, 114mm			64, 89, 114mm	64, 89, 114mm
Louvres (Cedar)	68, 90mm	68, 90mm			68, 90mm	68, 90mm
Angles	45° or 60°	45° or 60°	45° or 60° Normal	45° or 60° Reverse	85° Normal	85° Reverse
Louvre Facing	Normal	Reverse				
Projection (Basswood)	4, 8, 17, 27mm	0, 2, 9, 17mm				
Projection (Cedar)	8, 9, 17mm	0, 3, 9mm				
Finish (Basswood)	Painted, Stained	Painted, Stained	Painted, Stained	Painted, Stained	Painted, Stained	Painted, Stained
Finish (Cedar)	Painted, Oiled or Lacquered	Painted, Oiled or Lacquered			Painted, Oiled or Lacquered	Painted, Oiled or Lacquered
Note: For Flat blade louvres (both Basswood & Cedar) add 2mm to above Projection sizes						

SPECIFICATIONS



# Basswood Shutters

## Plantation Specifications

### Basswood Plantation Specifications

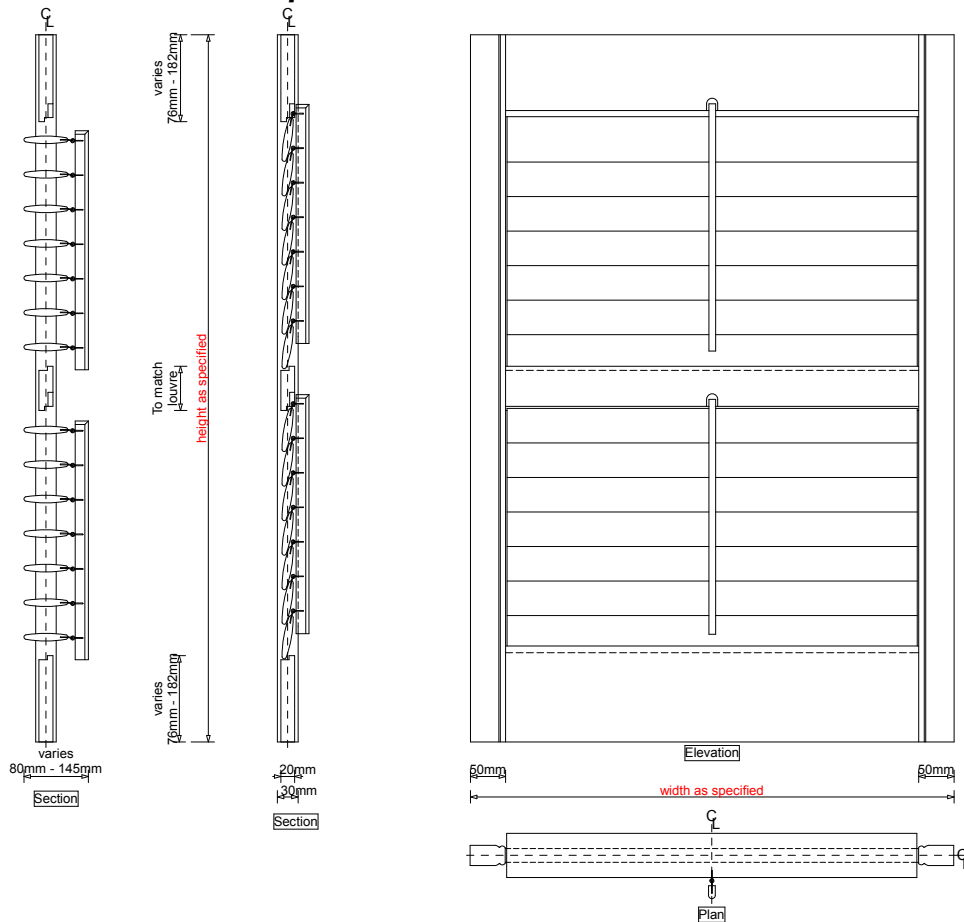

Louvre Size		
Type	Size	Options
Louvre - Aerofoil	47.6mm x 12mm	Half Open, Fixed, Ventilated, Fixed Non-Ventilated
Louvre - Aerofoil	64mm x 12mm	" " " " " " " " " "
Louvre - Aerofoil	89mm x 12mm	" " " " " " " " " "
Louvre - Aerofoil	114mm x 12mm	" " " " " " " " " "
Louvre - Flat blade	64mm x 12mm	" " " " " " " " " "
Louvre - Flat blade	89mm x 12mm	" " " " " " " " " "
Louvre - Flat blade	114mm x 12mm	" " " " " " " " " "

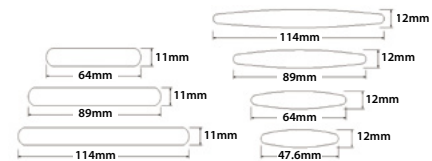

Finish	
Type	Options
Stain	Nature, Oak, Rose, Mahogany, Black walnut, Desert, Ash, Gum-nut, Maple, Coffee bean, Black, or custom colour
Painted	White, Snow, Swiss coffee, Creamy, Butter, Super white, Pearl white, Eggshell, Pearl, Bristle half, Antique white, White on white or custom painted

Width & Height Hinged	
Type	Size
Maximum Width	900mm (Single Panel hinged)
Maximum Width	650mm (Bi-fold Panel)
Maximum Width	1000mm (Sliding or Fixed)
Minimum Width	250mm (Single Panel)
Minimum Height	260mm
Maximum Height	2800mm

Stile & Rails		
Type	Size	Options
Stile	50mm x 30mm Colonial	Square, Rabbet, D-mould
Top Rail	70mm - 160mm x 20mm (varies, depends on height of panel)	
Mid Rail	64, 90, 114mm x 20mm (varies, depends on Louvre size)	
Bottom Rail	70mm - 160mm x 20mm (varies, depends on height of panel)	
Tilt Bar	19mm x 12mm centred	Left, Centre, Right Clear View

Recess	
Size	Please Note: Varies, depending on louvre size. Size of 150mm based on 114mm louvre
100mm - 150mm	

Construction	
Type	Size
Joints	Mortise and Tenon (Top, Middle, Bottom Rail)
Tension Screw & Spring for Louvre	8g x 70mm Wood Screw Stainless Steel
Louvre Dowels & Spring	Ø4 & Ø 6, 2 Plastic Dowels, Carbon Steel Spring
Eye Screw	Stainless Steel
Pin for Metal Tilt Rod	2g x 20mm, Brass
Clear View Tilt Rod	3mm x 14mm, Metal

Track Systems		
Type	Multi-fold 25	Single Run 60
Maximum Width	650mm per Panel (maximum 8 x Panels on each side)	900mm per Panel (maximum 6 x Panels on each track)
Maximum Height	3000mm	3000mm
Maximum Weight	25kg per Panel	60kg per Panel

SPECIFICATIONS

# Basswood Shutters

## - Plantation Construction

### Basswood Plantation Construction

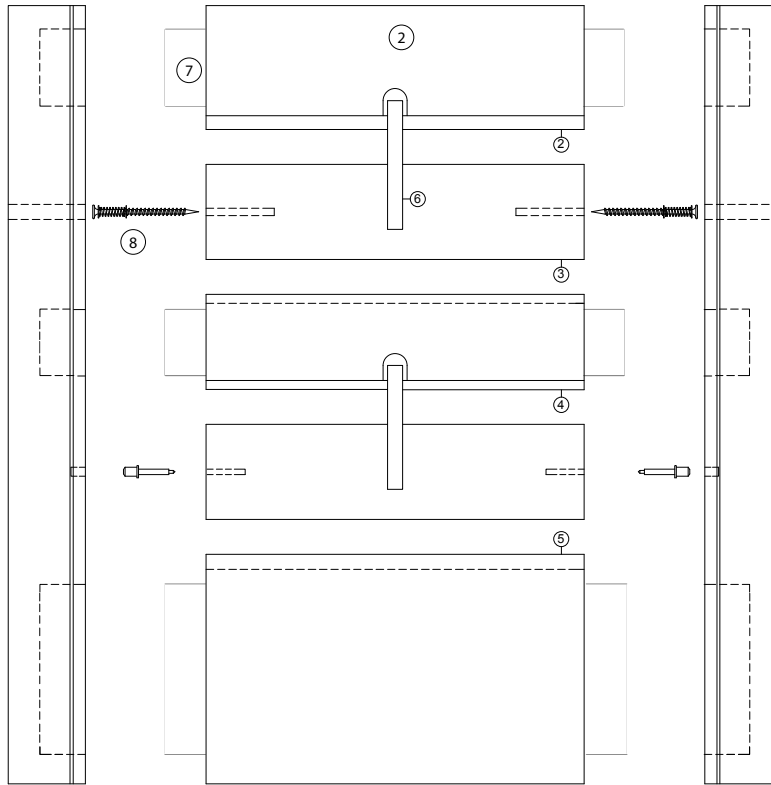

#### Component List

1. Stile
2. Top Rail
3. Louvre
4. Mid Rail
5. Bottom Rail
6. Tilt Bar
7. Mortise & Tenon joint
8. Tension Screw
9. Louvre Dowel
10. Eye Screw

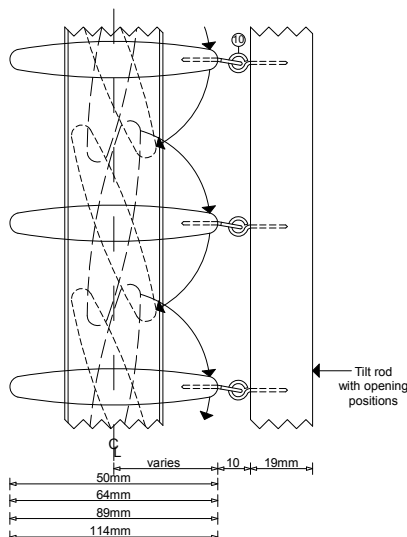
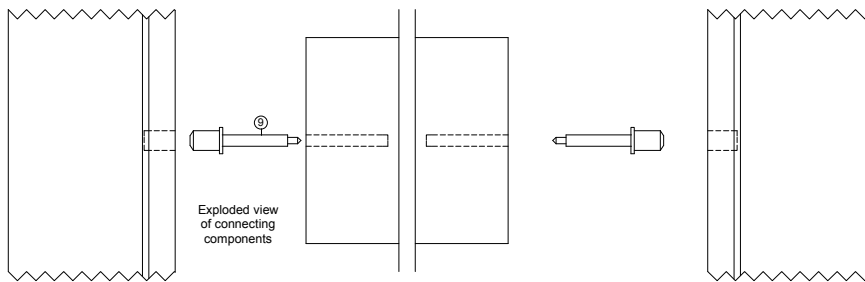

#### Construction

The Basswood shutter is constructed using a mortise and tenon joint to join the stiles, middle rail and bottom rail together as one frame. As the shutter height and rail size increase so does the size of the mortise and tenon joint. This strengthens, braces and prevents the frame from twisting, bowing or sagging. The louvres are mounted to the stile using the louvre dowel components, the tilt bar is then mounted to the louvres with the eye screws. The tension screw is then mounted through the stile into the louvre and tensioned. The mid rail must be used when the shutter is over 1800mm in height. This is designed to give greater strength to the shutter frame. The benefit of the mid rail option is that it allows the shutter louvres to have two sections at different angles for privacy, light and airflow. Maximum panel height for Basswood shutters with a mid rail is 2800mm, without a mid rail maximum height is 1800mm.

SPECIFICATIONS

# Basswood Shutters

## Plantation Clear View Construction

### Basswood Clear View Construction

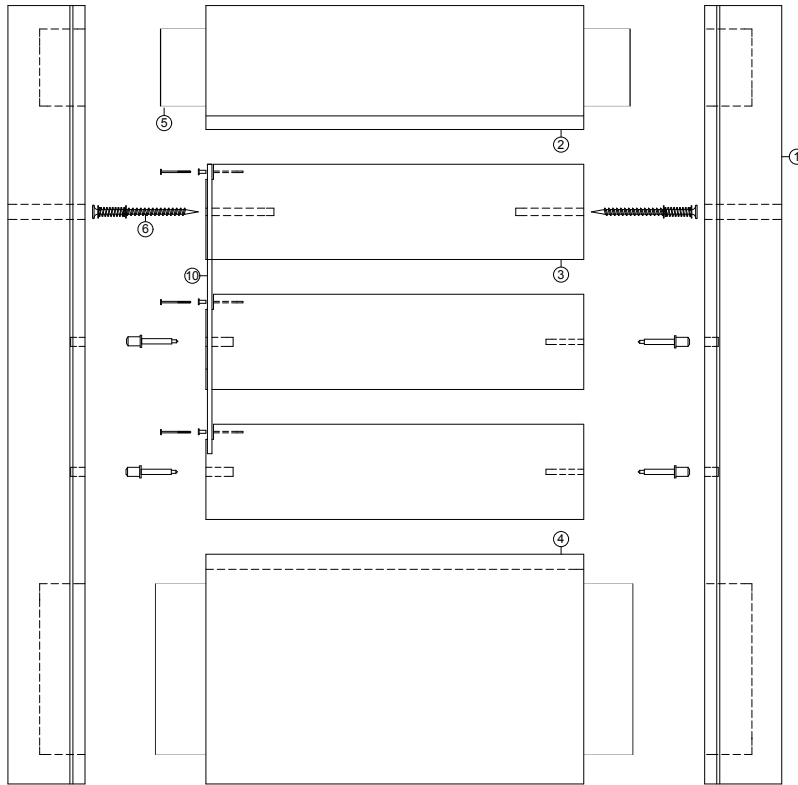

#### Component List

1. Stile
2. Top Rail
3. Louvre
4. Bottom Rail
5. Mortise & Tenon Joint
6. Tension Screw
7. SS Nail
8. SS Nut
9. LouvreDowel
10. Clear View Aluminium

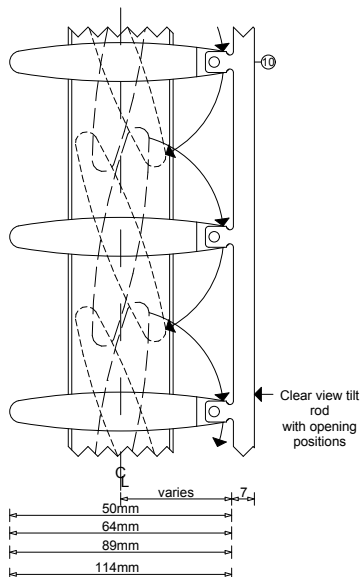
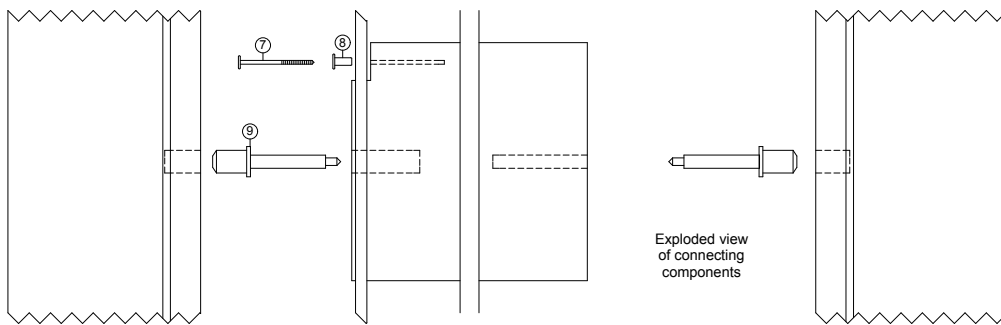

#### Construction

The Clear View shutter is constructed the same way as the standard Plantation shutter with the exception of the tilt bar which is replaced with the Clear View metal tilt rod option. This tilt bar is rebated into the side of the louvre blade (on the reverse side of the panel) allowing for cleaner lines with unobtrusive view through the shutter when the louvres are open or closed. This option is ideal for sliding shutter applications as this decreases light gap measurements and allows each shutter panel to sit closer to one another.



# Cedar Shutters

## - Cedar Plantation Specifications

### Cedar Plantation Specifications

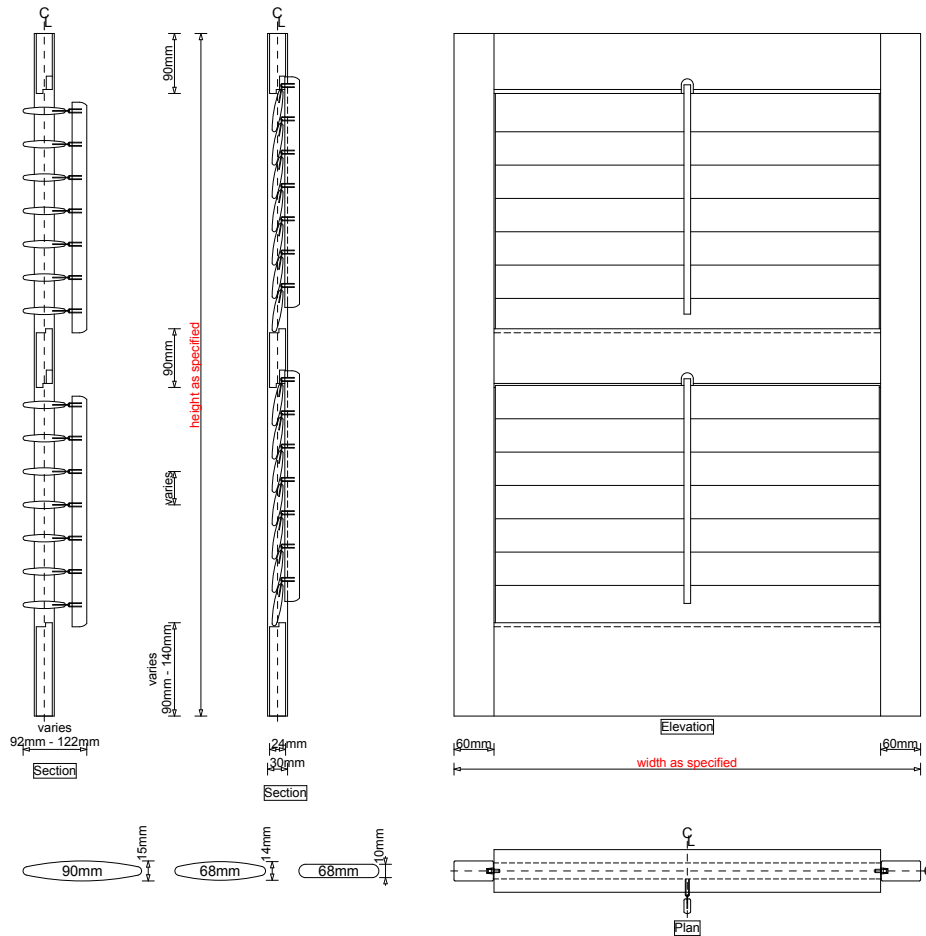

<b>Louvre Size</b>		
<b>Type</b>	<b>Size</b>	<b>Options</b>
Louvre - Standard	68mm x 10mm	Half Open, Fixed, Ventilated, Fixed Non-Ventilated
Louvre - Aerofoil	68mm x 14mm	" " " " " " " " " "
Louvre - Aerofoil	90mm x 15mm	" " " " " " " " " "
<b>Width &amp; Height Hinged</b>		<b>Construction</b>
<b>Type</b>	<b>Size</b>	<b>Type</b>
Maximum Width	950mm (Single Panel)	Joints
Maximum Width	500mm (Bi-fold Panel)	Pivot Pin for Stile/Louvre
Minimum Width	250mm (Single Panel)	Bush for Stile/Louvre
Minimum Height	260mm	Staples for Tilt Bar/Louvre
Maximum Height	3000mm	<b>Size</b>
		Ø10 Dowels (Top, Middle, Bottom Rail)
		Ø10 x 18mm Pin (Nylon T66)
		Ø8 x 10mm Bush (Nylon T66)
		12mm for Tilt Bar (Steel)
		8mm for Louvre (Steel)
<b>Finish</b>		<b>Stile &amp; Rails</b>
<b>Type</b>		<b>Type</b>
Oiled		Stile
Lacquered	Clear (polyurethane)	<b>Size</b>
Painted	Range standard colours or custom colour	60mm x 30mm
		<b>Options</b>
		Square
		Rabbit
		D-mould
<b>Recess</b>		<b>Top Rail</b>
<b>Size</b>	<b>Please Note:</b> Varies, depends on Louvre size. Size, 122mm based on 90mm	90mm x 24mm
92mm - 122mm		<b>Mid Rail</b>
		90mm x 24mm
		Shutters over 1500mm 1 mid-rail
		Shutters over 2950mm 2 mid-rails
		<b>Bottom Rail</b>
		90mm - 140mm x 24mm
		(varies, depends on height of panel)
		<b>Tilt Bar</b>
		22mm x 12mm centred
		Left, Centre, Right or Clear View
<b>Track Systems</b>		
<b>Type</b>	<b>Multi-fold</b>	<b>Single Run</b>
Maximum Width	620mm per Panel (maximum 8 x Panels on each side)	950mm per Panel (maximum 6 x Panels on each track)
Maximum Height	3000mm	3000mm
Maximum Weight	25kg per Panel	60kg per Panel

SPECIFICATIONS

# Cedar Shutters

## - Cedar Plantation Construction

### Cedar Plantation Construction

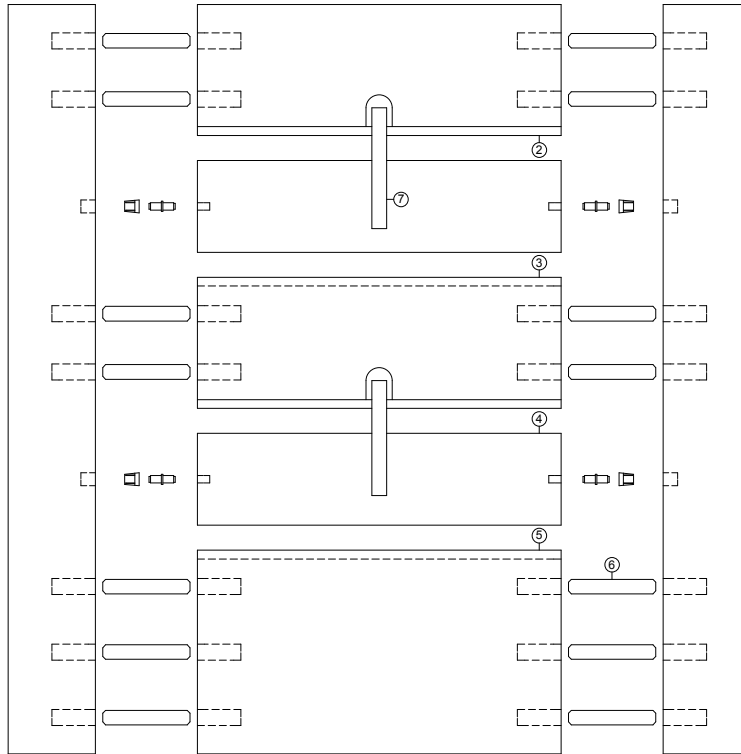

#### Component List

1. Stile
2. Top Rail
3. Mid Rail
4. Louvre
5. Bottom Rail
6. Dowel Joint
7. Tilt Bar
8. Pivot Bush
9. Pivot Pin
10. Staples

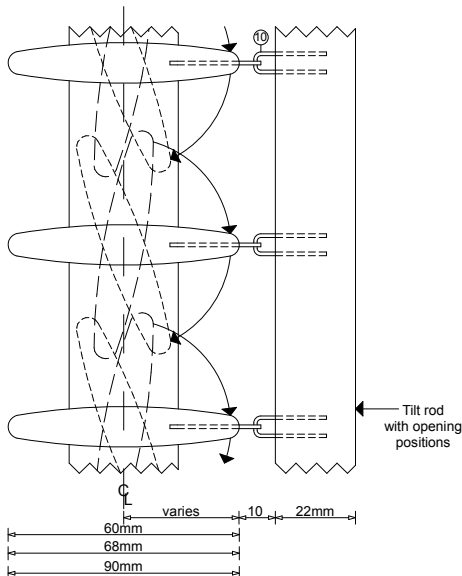
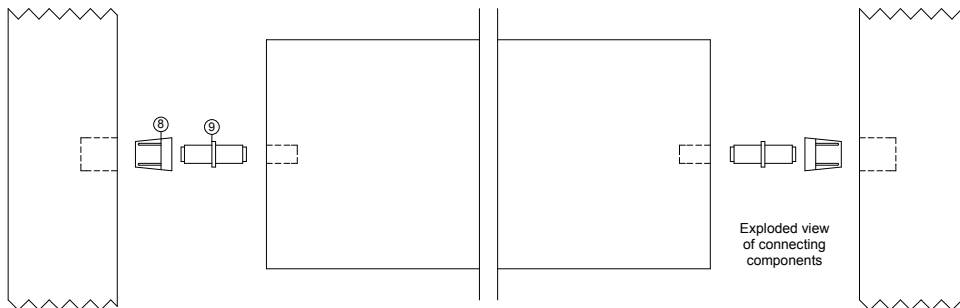

#### Construction

The Cedar shutter is constructed using hardwood dowelled joints and water based glue that are glued in place to join the stiles, middle rail and bottom rail together as one frame. The dowel size is Ø10mm. All rails have 2 dowels which strengthens, braces and prevents the frame from twisting, bowing or sagging. The louvres are mounted to the stile using the louvre pivot pin and stile bush components. The tilt bar is then mounted to the louvres with staples. A mid-rail must be used when the shutter is over 1500mm in height. This is designed to give greater strength to the shutter frame. Mid rails also allow the shutter louvres to have two sections at different angles for privacy, light and airflow. If the shutter is over 2950mm in height, two mid rails will be necessary.

# Basswood & Cedar Shutters

## - Special Shape Shutters

### Special Shape Shutters

Shaped panels are designed to cover architecturally or irregular designed windows or openings. Their main attraction is the ability to follow the shape of these openings, keeping the integrity of the design.

(note: not available in Basswood 50mm Flat Blade)

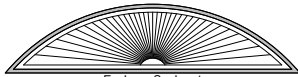

Eyebrow Sunburst  
Available louvre - 89mm

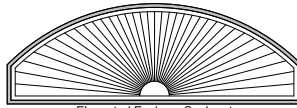

Elongated Eyebrow Sunburst  
Available louvre - 89mm

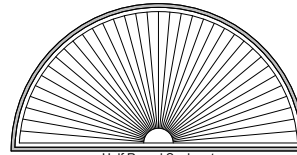

Half Round Sunburst  
Available louvre - 89mm

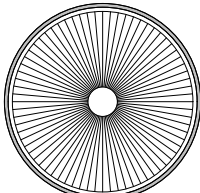

Circle Sunburst  
Available louvre - 89mm

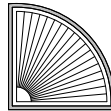

Quarter Sunburst  
Available louvre - 89mm

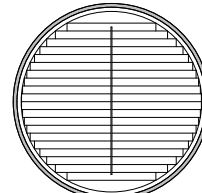

Circle with Horizontal Louvres  
Available louvres - 50mm, 64mm, 89mm  
Louvre open style - Full open or Half open  
Tilt Rod - Plantation only

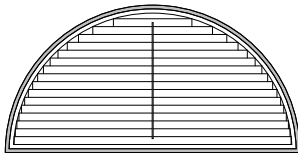

Sunburst with Horizontal Louvres  
Available louvres - 50mm, 64mm, 89mm  
Louvre open style - Full open or Half open  
Tilt Rod - Plantation only

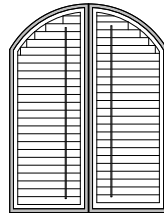

Arch  
Available louvres - 50mm, 64mm, 89mm  
Louvre open style - Full open or Half open  
Tilt Rod - Plantation or Clear View

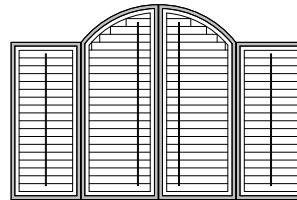

Arched Shutters with panel to both sides  
Available louvres - 50mm, 64mm, 89mm  
Louvre open style - Full open or Half open  
Tilt Rod - Plantation or Clear View

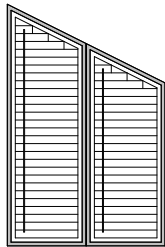

Rake  
Available louvres - 50mm, 64mm, 89mm  
Louvre open style - Full open or Half open  
Tilt Rod - Plantation or Clear View

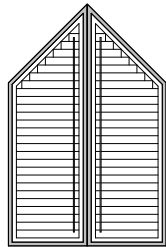

Triangle  
Available louvres - 50mm, 64mm, 89mm  
Louvre open style - Full open or Half open  
Tilt Rod - Plantation or Clear View

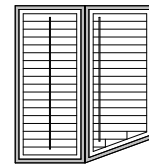

Tapered Shutters  
Available louvres - 50mm, 64mm, 89mm  
Louvre open style - Full open or Half open  
Tilt Rod - Plantation or Clear View

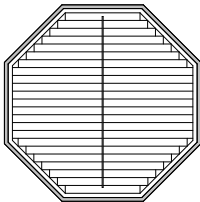

Octagon  
Available louvres - 50mm, 64mm, 89mm  
Louvre open style - Full open or Half open  
Tilt Rod - Plantation

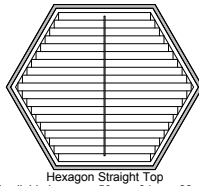

Hexagon Straight Top  
Available louvres - 50mm, 64mm, 89mm  
Louvre open style - Full open or Half open  
Tilt Rod - Plantation

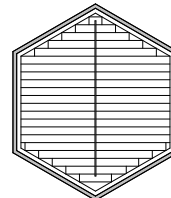

Hexagon Straight Sides  
Available louvres - 50mm, 64mm, 89mm  
Louvre open style - Full open or Half open  
Tilt Rod - Plantation

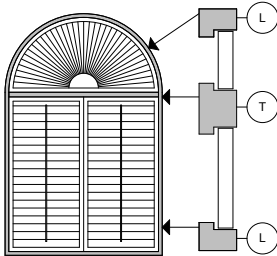

Sunburst at top with T-post and Standard Shutter at bottom  
Available Louvres in bottom shutter - 50mm, 64mm, 89mm  
Available louvres in Sunburst - 89mm  
Bottom Tilt Rod - Plantation or Clear View

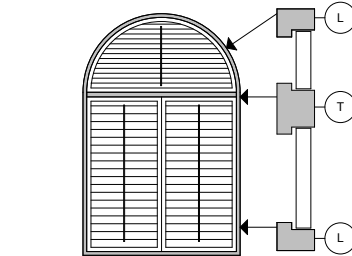

Sunburst with Horizontal Louvres at top with T-post and Standard Shutter at bottom  
Available louvres in bottom shutter - 50mm, 64mm, 89mm  
Available louvres in Sunburst - 89mm  
Bottom Tilt Rod - Plantation or Clear View

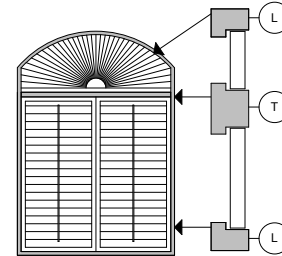

Elongated Eyebrow Sunburst at top with T-post and Standard Shutter at bottom  
Available louvres in bottom shutter - 50mm, 64mm, 89mm  
Available louvres in Sunburst - 89mm  
Bottom Tilt Rod - Plantation or Clear View

SPECIFICATIONS

# Basswood & Cedar Shutters

## Hardware Technical - Tracking systems, Hinges

### Hardware Overview

#### Tracking Systems

Window Treatments supplies two tracking systems: Multi-fold for bi-fold shutters, and Single Run for straight sliding shutters. For special applications Window Treatments can supply various track options to suit your requirements.

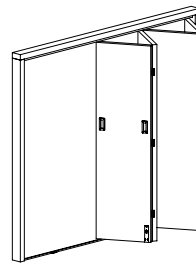

Multi-fold for Bi-fold shutters

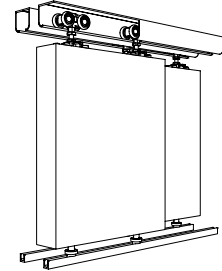

Single Run for straight sliding

#### Hinges

Depending on the type of shutter installation, Butt Hinge and Steadman Hinge are the standard hinges. For special applications, Window Treatments also supplies various hinge options such as Handle hinges to suit your requirements.

#### Butt Hinge

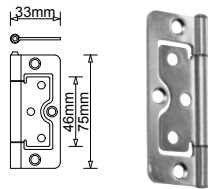

#### Steadman Hinge

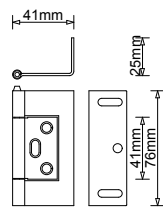

#### Handle Hinge

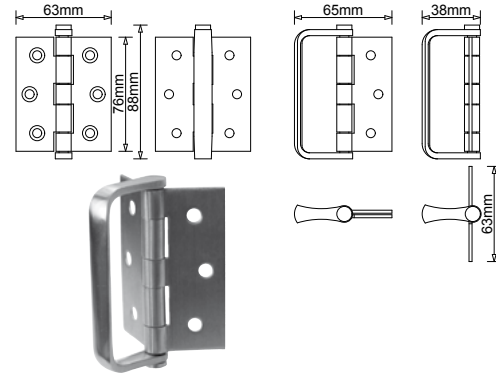

#### Barrel Bolt

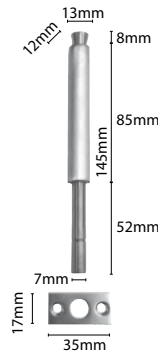

#### Magnetic Catch

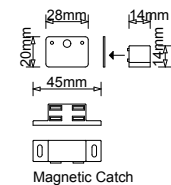

#### Magnetic Catch

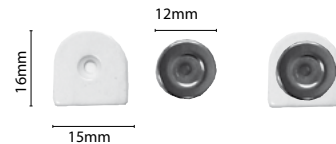

#### Ball Stop

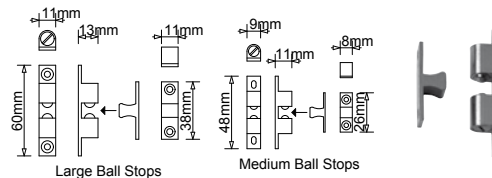

Type	Colours Available	Suitable for
Butt Hinge	Stainless Steel, Silver, Cream, White, Black, Antique Brass, Bright Brass	Square, Rabbet, T Post, L Frame
Steadman Hinge	Stainless Steel, Silver, Cream, White, Black, Antique Brass, Bright Brass	Hang Strip, protruding past window opening
Handle Hinge	Stainless Steel	Bi-fold, assists panel movement
Barrel Bolt	Stainless Steel	Bi-fold, Sliding, Panel
Ball Stops	Brass, Chrome	Securing Fixed Panel
Magnetic Catch	Brown, White, Black	Securing Bi-fold Panel

# Basswood & Cedar Shutters

## Hardware Technical - Sliding Single Run

### Application

- Widely used in lighter commercial and industrial applications
- To cover any width of opening, any number of panels can be used
- To accommodate different building designs, panels can slide to one or both sides
- Hinged panel for easy access may be incorporated into a sliding panel
- Where panels are fitted externally, a canopy is recommended



### Panel Specification

#### Track System: Single Run (individual Panels)

Max Panel Height: Basswood 3000mm  
Cedar 2700mm

For ease of operation it is recommended that the panel width should not exceed 75% of the panel height.

Panels for interior use can be of flush construction or glazed. Panels for industrial applications should be framed, ledged and braced.

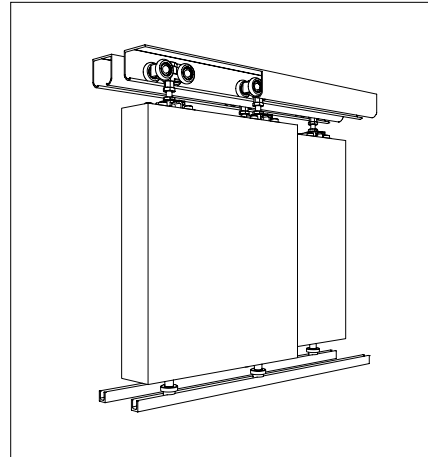

### Hardware Specification

Track : 80A  
Material : Aluminium  
Standard lengths : 2000mm, 3000mm, 4000mm, 6000mm  
Aluminium track available in mill or clear anodised finish.

Door Stop : 20DS (Stainless Steel)

Hangers (2 per door) :  
Interior : No. 57EN Hamger  
Hangers supplied with fixing plate and nylon tyred precision bearings. Vertical adjustment is simple and positive. Nylon tyre wheel hangers should not be used on installation involving temperatures exceeding 80°C.

Guide : No. 801S  
Spring loaded guide, nylon body and tip with stainless steel shaft and spring.  
Designed to slide in the No. 92 Threshold

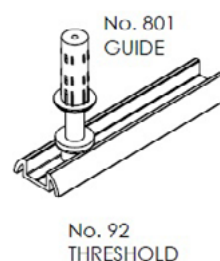
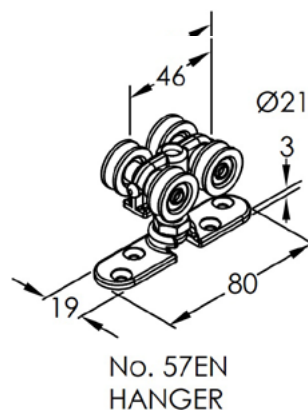
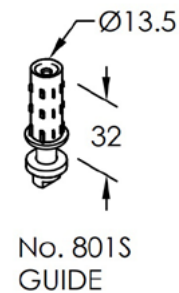
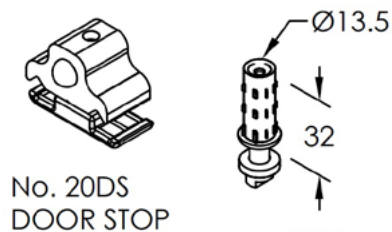

No. 92  
THRESHOLD

SPECIFICATIONS

# Basswood & Cedar Shutters

## - Hardware Technical - Multi-fold

### Application

- Suitable for residential and light commercial folding shutters with all panels of equal width. Panels can fold to one or both sides of the opening
- Pivot hardware enables a folding exterior shutter to be designed using equal width panels with no cutting down of the panel adjacent to the post.
- To cover any width opening, any number of folding units can be used.



### Panel Specification

#### Track System: Multi-fold (individual leaves)

Max Leaf Height:	Basswood	2500mm
	Cedar	2500mm
Max Leaf Width:	Basswood	700mm
	Cedar	750mm

Units of up to six panels can be pivoted to each side of the opening. A guide system across the floor must be used on units of three panels or more. Floating units consist of four to six panels. Shutters should be constructed to provide secure fitting for the pivot sets, hangers, hinges and guides.

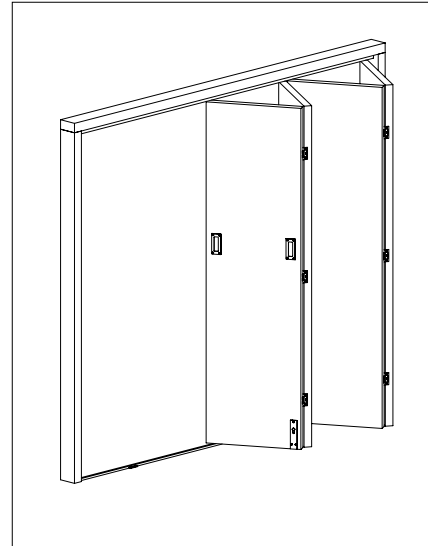

### Hardware Specification

Track - punched for soffit fitting: 80A  
 Material : Aluminium  
 Standard lengths : 2000mm, 3000mm, 4000mm, 6000mm

Top Pivot Assembly : 21EPNC Steel, Zinc dichromated, Nylon

Bottom Pivot : 21EPNC Steel, Zinc dichromated, Nylon

Door Stop : 20DS (Stainless Steel)

Hangers : No. 57EN Hanger  
 The hanger is fitted with four nylon tyred ballrace wheels. The adjustment bolt is attached to the top plate and secured in place with a blocking clip which allows easy installation. All steel parts are zinc dichromated.

Guide : No. 801S  
 Spring loaded guide for use with No.92 Threshold. Guide is nylon and stainless steel.

Threshold : No. 92  
 Threshold, aluminium, available in 2100mm, 3000mm, 4000mm, 6000mm

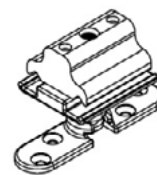

No.21EPNC  
Top Pivot

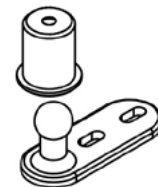

No. 21EPNC  
PIVOT

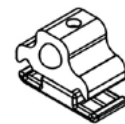

No. 20DS  
DOOR STOP

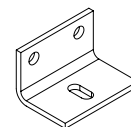

No. ADP1/60 Bracket

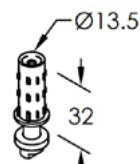

No. 801S  
GUIDE

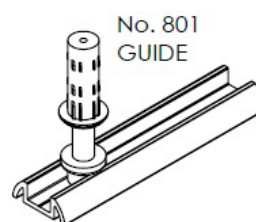

No. 92  
THRESHOLD

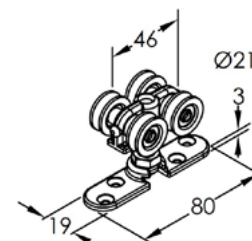

No. 57EN  
HANGER

# Aluminium Shutters

## Introduction

Window Treatment's traditional European styled Aluminium shutters are an aesthetically pleasing and versatile window management system suitable for both interior and exterior applications. The hardwearing powder coated aluminium is available in four baked enamel colours; silver, satin black, pearl white and new birch.

Aluminium shutters may be used for a variety of reasons: visibility and airflow, controlling the amount of sunlight that enters a room, privacy, security and the ability to enhance the aesthetics of a building or terrace access adding to practicality and mood of any interior or exterior area. They can be either fixed permanently in place, hinged, bi-fold or sliding depending on your preference and application. Louvres can be adjustable or fixed within the shutter frame. Full height shutters are made with a mid-rail which separates the upper and lower portions of the shutter, with operable louver shutters this gives greater control as the louvres above the mid-rail can be operated independently from the louvres below the mid-rail. A clear view metal tilt rod is used placed on the reverse side of the shutter allowing you to adjust all louvres at once by simply tilting one louver on the front side of the shutter. The clear view mechanism provides cleaner lines, preserves the view and helps to decrease light gap measurements on sliding shutter applications. Note that a front mounted tilt bar can not be used on our aluminium shutters.



## Quick Glance

Type		Aluminium
Louvres	Louvre Size	89mm
Tilt Bar	Tilt Bar Position Clear View	N/A Yes
Style	Hinged Bi-fold Straight Sliding Fixed Louvres (ventilated) Fixed Louvres (non-ventilated) Special Shape Shutters	Yes Yes Yes Yes Yes No
Stile Options	Square Rabbit D-mould	Yes No Yes
Motorised Options		Yes
Hardware	Tracking Systems Hardware	Yes Yes
Frame Options	Stiles Mid-rail Light Stop Hang Strips L Frames Z Frames T Post U Channel Corner Post Bay Window Post	Yes Yes *Yes - constructed from Basswood No Yes No Yes Yes *Yes - constructed from Basswood *Yes - constructed from Basswood
Finish	Stained Oiled Lacquered Painted Powder coated	No No No No Yes

# Aluminium Shutters

- Tilt Rod, Louvre Size, Louvre Style,

## Tilt Rod Control Position:

### Clear View

The Clear View control for Aluminium shutters is a metal tilt rod rebated into the side of the louvre blade on the reverse side of the panel. This allows for cleaner lines and a clear view through the shutter once the louvres are opened or closed.

The standard Clear View tilt bar position is on the hinged stile side of the louvre blades. Aluminium shutters that are installed in hard to reach places will come with a hooked pole and have a small eyelet screwed into the bottom louvre which allows the louvres to be repositioned easily using the pole provided. The Clear View mechanism when used in sliding shutter applications decreases the light gap measurements and allows each shutter panel to sit closer to one another reducing the depth of the shutters when stacked.

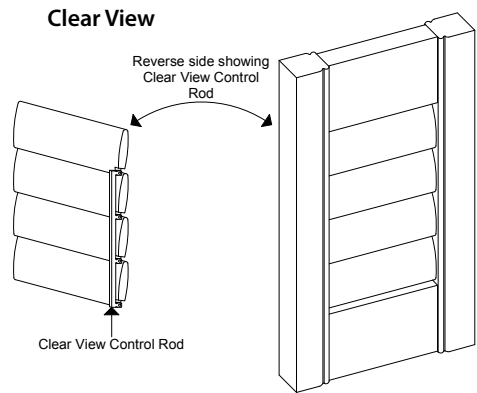

### Louvre Size and Type

Aluminium shutters are available in an areofoil blade which is elliptical in shape (i.e. thicker in the middle and tapered to the front and back).

Type	Size	Thickness
Aluminium Aerofoil	89mm x 11mm	1.4mm

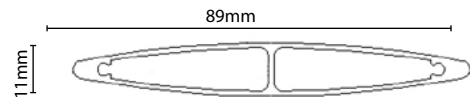

### Louvre Style for Special Shape Shutters

Special shapes are not available in Aluminium shutters. Please refer to our Basswood and Cedar Shutter sections if special shapes are required.

### Stiles

Window Treatments supplies 2 stile options for Aluminium shutters: Square, and D-mould. D-mould stiles are used to provide a light block where two panels overlap or interlock.

Aluminium Square Stile

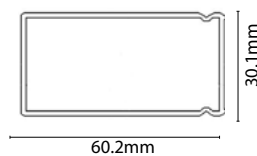

Aluminium D-mould Stile

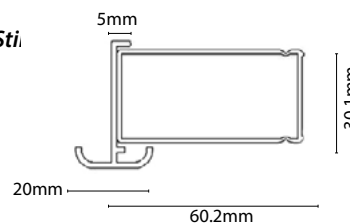

Square stile



Square Stile



Square & D-mould





# Aluminium Shutters

## Light stop, L frames, T frames & Mount types

### Light Stop

Shutter Type	Type	Frame Options	Benefit
Aluminium	Light Stop	Varies	Provides a light block where panels are hinged. Note: constructed from Basswood

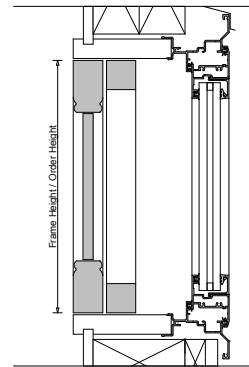
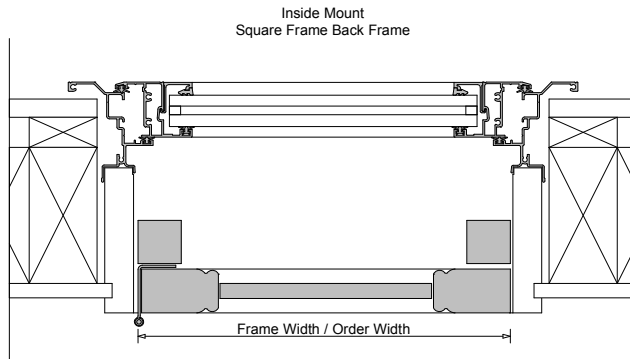

### L Frame

Shutter Type	Type	Frame Options	Benefit
Aluminium	L Frame	Standard	L Frames are used to provide hanging options for single and multiple panels for outside and inside mount applications using a Butt or Steadman hinge. Using a standard frame with a Steadman hinge allows you to protrude the panel past the window opening. This gives you the ability to hang the shutter panel square in the frame and closes light gap for flush mounted hinges. Ideal when there is no architrave in the opening.

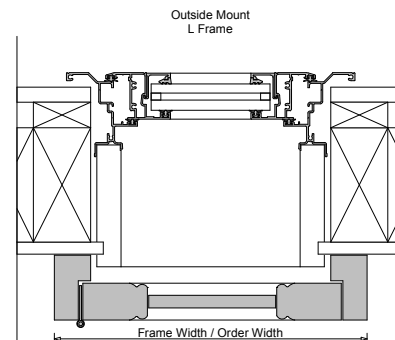
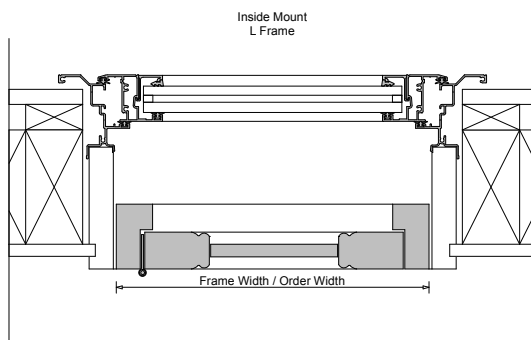
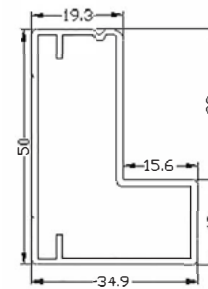

### T Post

Shutter Type	Type	Frame Options	Benefit
Aluminium	T Post	Standard	T Post are used to provide hanging options for single and multiple panels for outside and inside mount applications using a Butt hinge. Gives you the ability to hang the shutter panel square in the frame. The T Post closes the light gap for flush mounted hinges. Ideal when there is no architrave in the opening. Available as Standard.

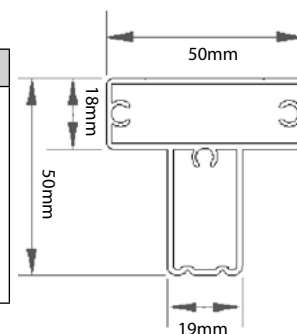

SPECIFICATIONS

# Aluminium Shutters

## U Channel, Corner Post, Bay Window Post & Mount types, Panel Types

### U Channel

Shutter Type	Type	Frame Options	Benefit
Aluminium	U Channel	Top, Bottom	Top and bottom 'U Channels' are ideal for incline roof applications or when access to windows is not required. The louvres can open and close and the panel can easily be removed by lifting the shutter up into the top channel and out at the bottom. To refit the reverse applies.

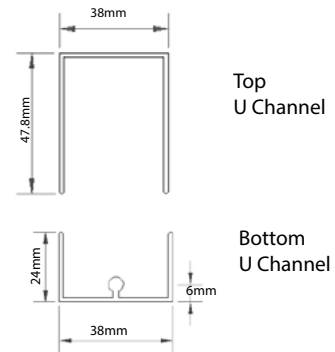

### Corner Post

Shutter Type	Type	Frame Options	Benefit
Aluminium	Corner Post	Corner Post	Corner Posts are used to provide hanging options for single and multiple panels within a corner application. Closes light gap for flush mounted hinges. Corner Posts are manufactured according to the size required for each installation. Note: constructed from Basswood

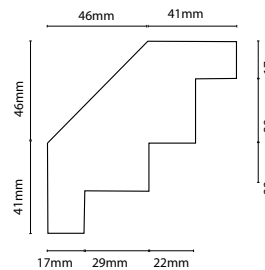
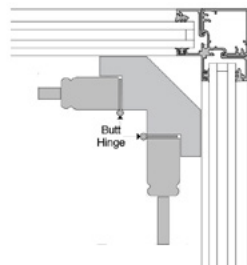

### Bay Window Post

Shutter Type	Type	Frame Options	Benefit
Aluminium	Bay Window Post	Bay Window Post	Bay Corner Posts are used to provide hanging options for single and multiple panels within a bay window application. Closes light gap for flush mounted hinges. Bay Window Posts are manufactured according to the size required for each installation. Note: constructed from Basswood

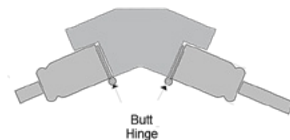

Can be custom made to suit

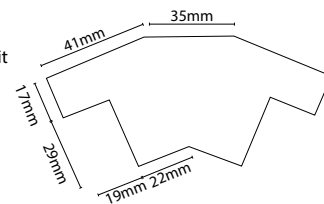

### Panel Types & Hinging Options

Panel types refers to the variations of each type of shutter; single panel fixed, single panels hinged, bi-folds, L Frame, T Post, Straight sliding, and bi-foldomg variations.

The type of hinge used for a single panel, bi-fold, L frame and T post applications is a butt hinge. However if you require your panel to protrude past the window opening then a Steadman hinge is required hinged from a hang strap.

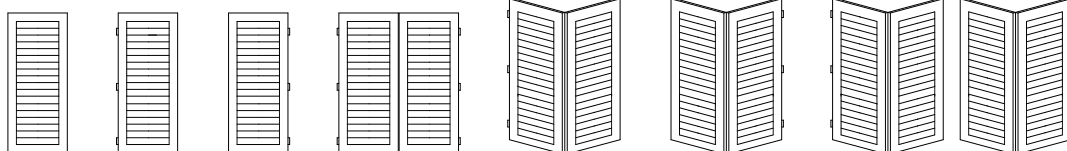
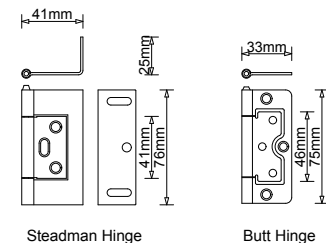

Single panel fixed

Single panel hinged at left

Single panel hinged at right

Set of single panels hinged left and right

Single bi-fold shutter pivoted at left

Single bi-fold shutter pivoted at right

Two sets bi-fold shutters

1-A

1-B

2-A

2-B

2-C

2-D

# Aluminium Shutters

## - Panel Types & Hinging options contd.

### L Frame and T Post Hinged options

When tracks are not feasible, L frame and T Posts are used to provide options for single and multiple panels within an opening or outside the opening window (see examples below).

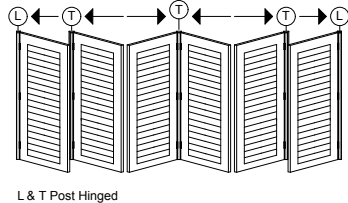

L & T Post Hinged

#### Key

T means	Panel is hinged from a T Post or closes onto a T Post
L means	Panel is hinged from a L Frame or closes onto a L Frame
→ means	Panel direction to the right
← means	Panel direction to the left

#### One Panel variations:



#### Two Panel individually hinged & Two Panel bi-fold variations:

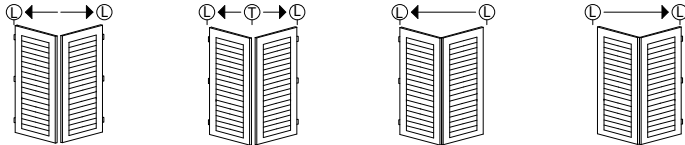

#### Three Panel individually hinged variations:

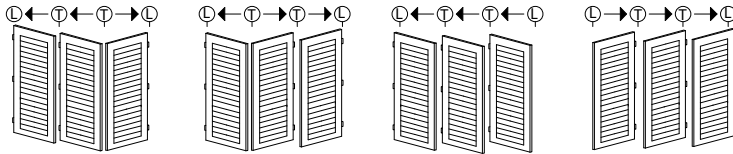

#### Three Panel bi-fold variations:

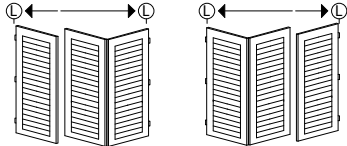

#### Four Panel individually hinged variations:

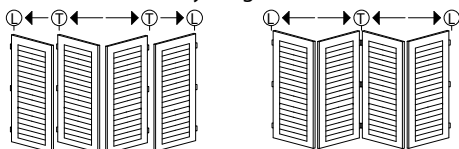

#### Four Panel bi-fold variations:

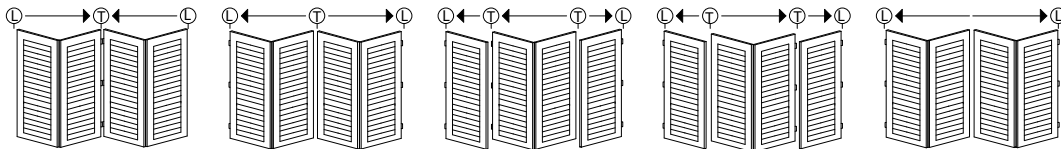

#### Six Panel individually hinged variations:

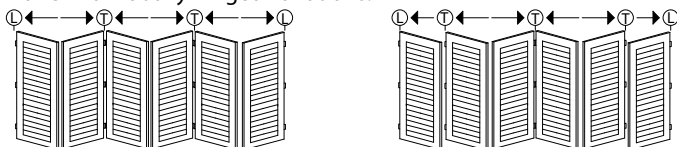

#### Six Panel bi-fold variations:

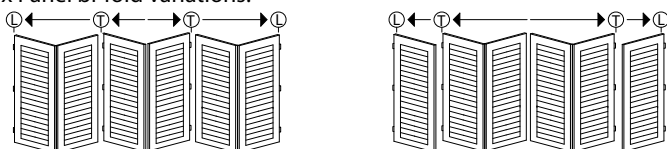

SPECIFICATIONS

# Aluminium Shutters

## Fixed Louvre Shutters, Overview specifications

### Fixed Shutters

Fixed louvres are permanently open (ventilated - Type A) or permanently shut (non-ventilated - Type D). Permanently open means that there is always ventilation while blocking line of sight. Fixed louvres may be employed for a variety of reasons: to control the amount of sunlight that enters a room, to provide privacy and security, protect against weather, unwanted intrusion or damage and to enhance the aesthetics of a building.

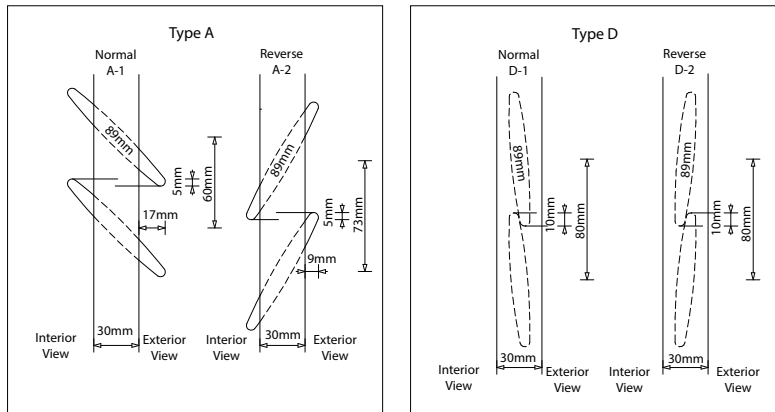

	Type A		Type D	
	Normal A-1	Reverse A-2	Normal D-1	Reverse D-2
Stile (Aluminium)	60 x 30mm	60 x 30mm	60 x 30mm	60 x 30mm
Louvres (Aluminium)	89mm	89mm	89mm	89mm
Angles	45° or 60°	45° or 60°	85°	85°
Louvre Facing	Normal	Reverse	Normal	Reverse
Projection (Aluminium)	17mm	9mm		
Finish (Aluminium)	Powder coated	Powder coated	Powder coated	Powder coated

### Overview Aluminium Shutter Specifications:

Louvre Size		
<b>Type</b>	<b>Size</b>	<b>Options</b>
Louvre - Aerofoil	89mm x 11mm	Half Open, Fixed, Ventilated, Fixed Non-Ventilated

Width & Height Hinged	
<b>Type</b>	<b>Size</b>
Maximum Width	1100mm (Single Panel)
Maximum Width	700mm (Bi-fold Panel)
Minimum Width	300mm (Single Panel)
Minimum Height	300mm
Maximum Height	2700mm
Note: Shutters over 1800mm in height will be constructed with a mid-rail	

Finish		Stile & Rails		
<b>Type</b>	<b>Colours</b>	<b>Type</b>	<b>Size</b>	<b>Options</b>
Powder Coated	Silver, Satin black, Pearl white, New birch	Stile	60mm x 30mm	Square D-mould
<b>Recess</b>		Top Rail	25mm x 78.6mm	
<b>Size</b>	Louvre size 89mm	Mid Rail	25mm x 81.6mm	
122mm		Shutters over 1.800mm 1 mid-rail		
		Bottom Rail	72.4mm - 141mm x 25mm	
		(varies, depends on height of panel)		
		Tilt Rod	Rebated on reverse side of panel	Clear View only

Track Systems		
<b>Type</b>	<b>Multi-fold</b>	<b>Single Run</b>
Maximum Width	700mm per Panel (maximum 8 x Panels on each side)	1200mm per Panel (maximum 6 x Panels on each track)
Maximum Height	2700mm	2700mm
	Note: Shutters over 1800mm in height will be constructed with a mid-rail	Note: Shutters over 1800mm in height will be constructed with a G mid-rail

# Aluminium Shutters

## Hardware Technical - Tracking systems, Hinges

### Hardware Overview

#### Tracking Systems

Window Treatments supplies two tracking systems: Multi-fold for bi-fold shutters, and Single Run for straight sliding shutters. For special applications Window Treatments can supply various track options to suit your requirements.

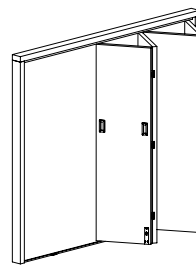

Multi-fold for Bi-fold shutters

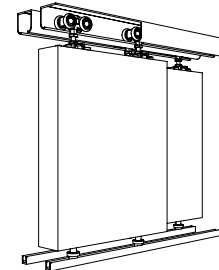

Single Run for straight sliding

#### Hinges

Depending on the type of shutter installation, Butt Hinge and Steadman Hinge are the standard hinges. For special applications, Window Treatments also supplies various hinge options such as Handle hinges to suit your requirements.

#### Butt Hinge

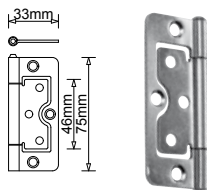

#### Steadman Hinge

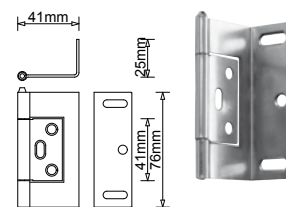

#### Handle Hinge

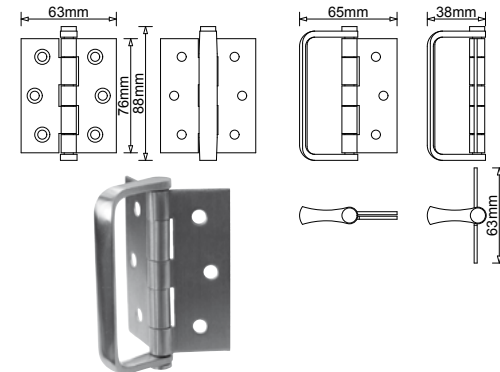

#### Barrel Bolt

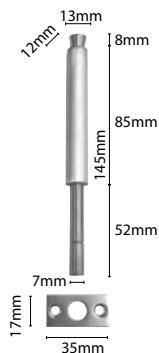

#### Magnetic Catch

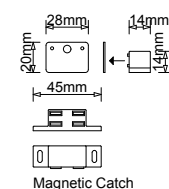

#### Magnetic Catch

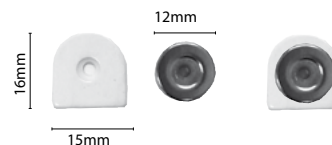

#### Ball Stop

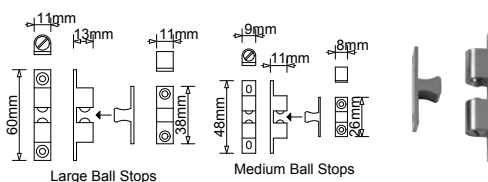

Type	Colours Available	Suitable for
Butt Hinge	Stainless Steel, Silver, Cream, White, Black, Antique Brass, Bright Brass	Square, Rabbet, T Post, L Frame
Steadman Hinge	Stainless Steel, Silver, Cream, White, Black, Antique Brass, Bright Brass	Hang Strip, protruding past window opening
Handle Hinge	Stainless Steel	Bi-fold, assists panel movement
Barrel Bolt	Stainless Steel	Bi-fold, Sliding, Panel
Ball Stops	Brass, Chrome	Securing Fixed Panel
Magnetic Catch	Brown, White, Black	Securing Bi-fold Panel

SPECIFICATIONS

# Aluminium Shutters

## - Hardware Technical - Sliding Single Run

### Application

- Widely used in lighter commercial and industrial applications
- To cover any width of opening, any number of panels can be used
- To accommodate different building designs, panels can slide to one or both sides
- Hinged panel for easy access may be incorporated into a sliding panel
- Where panels are fitted externally, a canopy is recommended



### Panel Specification

**Track System: Single Run (individual Panels)**

Max Panel Height: 2700mm

For ease of operation it is recommended that the panel width should not exceed 75% of the panel height.

Panels for interior use can be of flush construction or glazed. Panels for industrial applications should be framed, ledged and braced.

Aluminium panels should be constructed of box section, channel or angle framing, well braced and clad with flat or corrugated sheets.

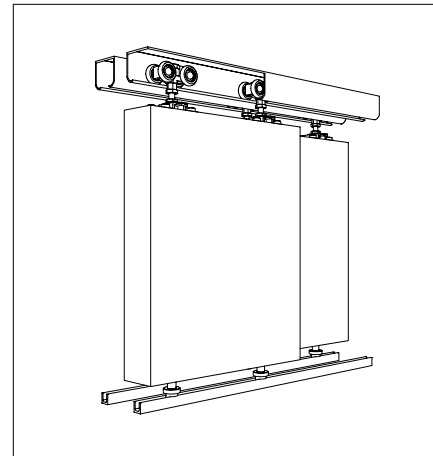

### Hardware Specification

Track : 80A  
 Material : Aluminium  
 Standard lengths : 2000mm, 3000mm, 4000mm, 6000mm  
 Aluminium track available in mill or clear anodised finish.

Door Stop : 20DS (Stainless Steel)

Hanger sets : No. 52EN/4-A  
 Stainless Steel hangers are fitted with nylon wheels on precision stainless steel ball race bearings. Vertical adjustment is simple and positive.

Guide : No. 21ER-A  
 With precision stainless bearing.

Channels  
 Aluminium & Polypropylene : 94PPA Mill or clear anodised  
 Standard lengths : 2000mm, 3000mm, 4000mm, 6000mm

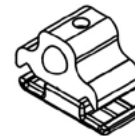

No. 20DS  
DOOR STOP

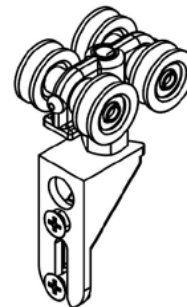

No. 52EN/4-A  
INTERMEDIATE  
HANGER



No. 21ER-A  
END GUIDE

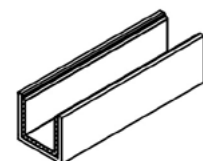

No. 94PPA  
CHANNEL

SPECIFICATIONS

# Aluminium Shutters

## - Hardware Technical - Multi-fold

### Application

- Suitable for residential and light commercial folding shutters
- Leaves can be either end folding or centre folding
- Leaves can fold to one or both sides of the opening
- Pivot hardware enables an end folding internal partition to be designed using standard width panels with no need to reduce the width of the leaf adjacent to the post.
- To cover any width opening, any number of folding units can be used.



### Panel Specification

**Track System: Multi-fold (individual leaves)**

Max Leaf Height: 2700mm

Max Leaf Width: 700mm

Designed to suit aluminium folding screens with all panels of equal width. Panels can fold to one or both sides of the opening. Pivot hardware enables an end folding internal partition to be designed using standard width panels with no need to reduce the width of the leaf adjacent to the post. All stainless steel hardware components are located inside the aluminium stile's recess for flush and secure fitting.

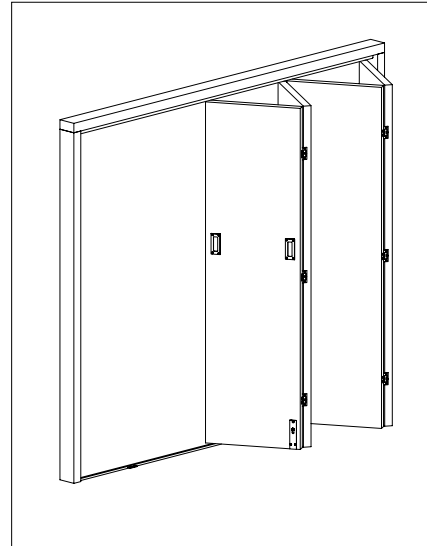

### Hardware Specification

Track - punched for soffit fitting: 80A

Material : Aluminium

Standard lengths : 2000mm, 3000mm, 4000mm, 6000mm

Pivot Sets : 21EP-A

Adjustable Top & Bottom Pivot

Door Stop : 20DS (Stainless Steel)

Hanger Set :

End Hanger : 52EN-A

Intermediate Hanger : 52EN/4-A

Stainless Steel hangers are fitted with nylon wheels on precision stainless steel ball race bearings. Vertical adjustment is simple and positive.

Guide : 21ER-A

With precision Stainless steel Bearing.

Channels : 94PPA

Aluminium channel, available in 2100mm, 3000mm, 4000mm, 6000mm

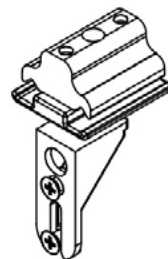

No. 21EP-A  
PIVOT



No. 52EN-A  
END HANGER

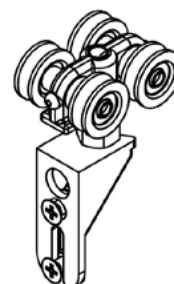
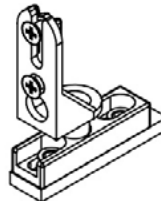

No. 52EN/4-A  
INTERMEDIATE  
HANGER



No. 21ER-A  
END GUIDE

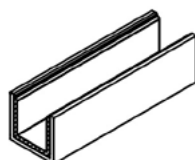

No. 94PPA  
CHANNEL

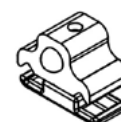

No. 20DS  
DOOR STOP

SPECIFICATIONS



# Aluminium Shutters

SPECIFICATIONS





# PVC Shutters



## Introduction

Window treatments traditional European styled PVC Shutters are the perfect interior window management system. PVC Shutters look like our Basswood shutters but offer a longer life span and more affordable price tag. PVC shutters will not absorb moisture, delaminate, split, crack and are excellent for kitchens and bathrooms where moisture may be a problem.

PVC Shutters may be used for a variety of reasons: visibility and airflow, controlling the amount of sunlight that enters a room, provide privacy and security and enhance the aesthetics of a building or terrace access adding to the practicality and mood of any interior.

PVC Shutters can either be fixed permanently in place, hinged, bi-fold or sliding depending on your preference and application. Louvres can be adjustable or fixed within the shutter frame. Full height shutters are made with a horizontal divider (mid-rail) which separates the upper and lower portions of the shutter. With operable louver shutters this gives greater control as the louvres above the mid-rail can be operated independently from the louvres below the mid-rail. A tilt bar is used for adjusting louver position and to keep louvres in uniform position. Alternatively a clear view metal tilt rod is placed on the reverse side of the shutter allowing you to adjust all louvres position by tilting one louver. This also allows for cleaner lines on the front of the shutter and helps to decrease light gap measurements on sliding shutter applications.



## Quick Glance

Type		PVC
<b>Louvres</b>	Louvre Size	64mm, 89mm, 114mm
<b>Tilt Bar</b>	Tilt Bar Position Clear View	Centre, Left or Right Yes
<b>Style</b>	Hinged Bi-fold Straight Sliding Fixed Louvres (ventilated) Fixed Louvres (non-ventilated) Special Shape Shutters	Yes Yes Yes Yes Yes No
<b>Stile Options</b>	Square Rabbit D-mould	Yes Yes Yes
<b>Motorises Options</b>		Yes
<b>Hardware</b>	Tracking Systems Hardware	Yes Yes
<b>Frame Options</b>	Stiles Mid-rail Light Stop Hang Strips L Frames Z Frames T Post U Channel Corner Post Bay Window Post	Yes Yes * Yes - constructed from Basswood * Yes - constructed from Basswood Yes Yes Yes * Yes - constructed from Basswood * Yes - constructed from Basswood * Yes - constructed from Basswood
<b>Finish</b>	Stained Oiled Lacquered Painted Powder coated	No No No Yes, Standard colours or custom colours No

SPECIFICATIONS

# PVC Shutters

## Tilt Rod, Louvre Size, Louvre Style,

SPECIFICATIONS

### Tilt Rod Control Position:

#### Plantation

Standard position for the tilt bar control on Plantation shutters is centred within the frame. Alternatively, the tilt bar can be positioned off-centred left or right. The off-centred option is mainly used for bi-fold panels to allow the panels to fold onto each other without hitting the tilt bar. A tilt rod (in conjunction with a hooked push pole) is also used for high/out of reach and special shaped shutters.

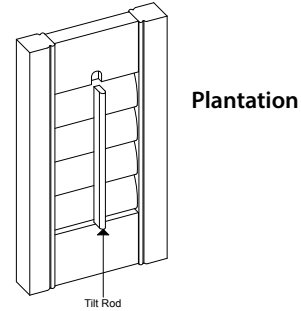

#### Clear View

The Clear View control option for PVC shutters is a metal tilt rod rebated into the side of the louvre blade on the reverse side of the panel. This allows for cleaner lines and a clear view through the shutter once the louvres are opened or closed. The standard ClearView tilt bar position is on the hinged stile side of the louvre blades. The Clear View option is also used for sliding shutter applications as this decreases light gap measurements and allows each shutter panel to sit closer to one another reducing the depth of the shutters when stacked.

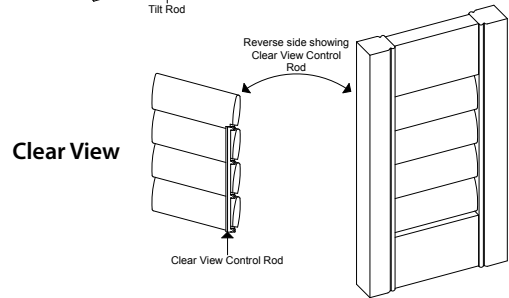

### Louvre Size and Type

PVC shutters are available in three sizes of areofoil blade which is elliptical in shape (i.e. thicker in the middle and tapered to the front and back). Louvre blades are reinforced with aluminium inserts.

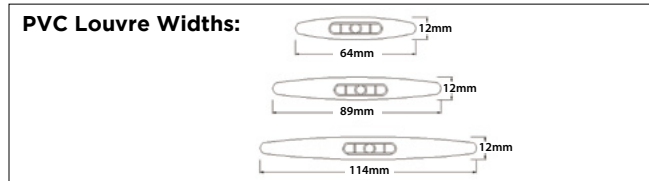

### Louvre Style for Special Shape Shutters

Special shapes are not available in PVC shutters. Please refer to our Basswood and Cedar Shutter sections if special shapes are required.

### Stiles

Window Treatments supplies three stile options for PVC shutters: Square, Rabbet and D-mould. D-mould stiles are used to provide a light block where two panels overlap or interlock. PVC stiles are reinforced with aluminium inserts.

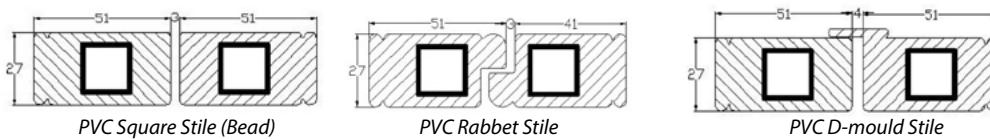

Square Stiles (Bead)



Square & Rabbet Stiles

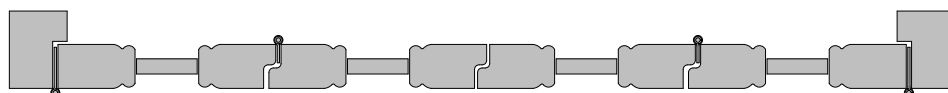

Square & D-mould



# PVC Shutters

## Light stop, L frames, T frames & Mount types

### Light Stop

Shutter Type	Type	Frame Options	Benefit
PVC	Light Stop	A4, A9, mm Varies Note: constructed from Basswood not PVC	Provides a light block where panels are hinged.

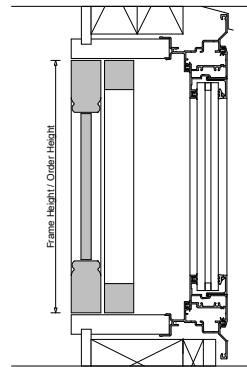
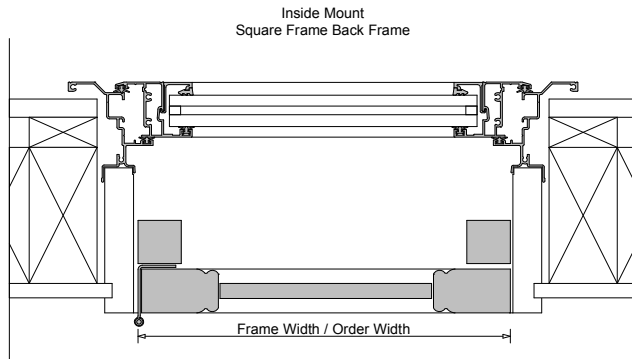
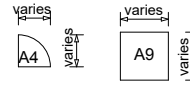

### L Frame

Shutter Type	Type	Frame Options	Benefit
PVC	L Frame	Beaded (standard - PVC) or Flat (constructed from Basswood)	L Frames are used to provide hanging options for single and multiple panels for outside and inside mount applications using a Butt or Steadman hinge. Using a Beaded standard frame or Flat frame with a Steadman hinge allows you to protrude the panel past the window opening. This gives you the ability to hang the shutter panel square in the frame and closes the light gap for flush mounted hinges. Ideal when there is no architrave in the opening.

Beaded (standard - PVC)

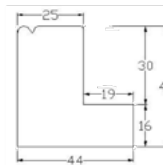

Flat (constructed from Basswood)

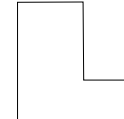

Inside Mount L Frame

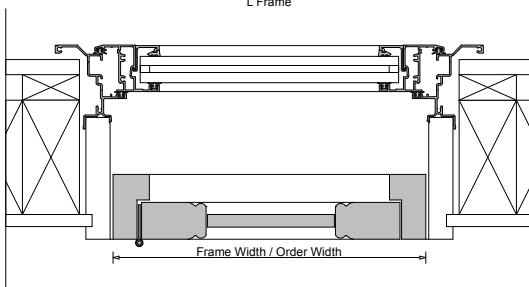

Outside Mount L Frame

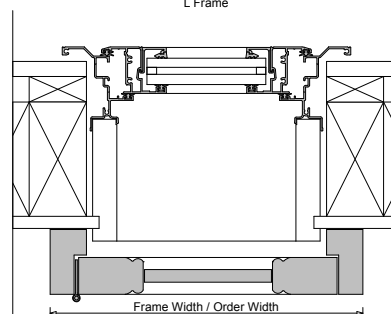

### T Post

Shutter Type	Type	Frame Options	Benefit
PVC	T Post	Beaded (standard - PVC) or Flat (constructed from Basswood)	T Posts are used to provide hanging options for single and multiple panels for outside and inside mount applications using a Butt hinge. Gives you the ability to hang the shutter panel square in the frame. The T Post closes the light gap for flush mounted hinges. Ideal when there is no architrave in the opening. 2 options Beaded or Flat.

Beaded (standard - PVC)



Flat (constructed from Basswood)

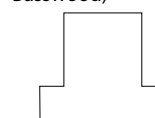

T-Post

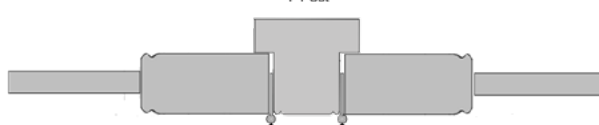

SPECIFICATIONS

# PVC Shutters

- Z Frame, U Channel, Corner Post, Bay Window Post & Mount types

SPECIFICATIONS

## Z Frame

Shutter Type	Type	Frame Options	Benefit
PVC	Z Frame	TP Plain TP Colonial TP Fancy TP Texas	Z Frames are used to provide hanging options for single and multiple panels within an opening. Plumbing the window frame closes the light gap for flush mounted hinges. The Z frame wraps around the reveal edge, making it ideal for covering out-of-square windows. 4 style options are available

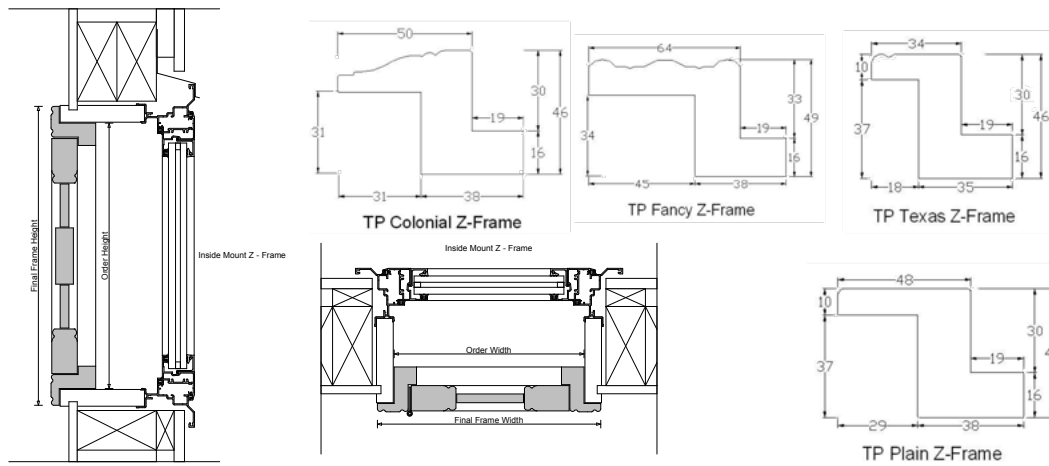

## U Channel

Shutter Type	Type	Frame Options	Benefit
PVC	U Channel	Top, Bottom	Top and bottom 'U Channels' are ideal for incline roof applications or when access to windows is not required. The louvres can open and close and the panel can easily be removed by lifting the shutter up into the top channel and out at the bottom. To refit the reverse applies. Note: U Channels are constructed from Basswood not PVC

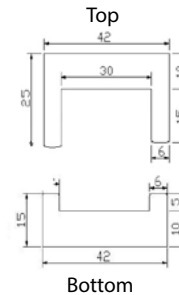

## Corner Post

Shutter Type	Type	Frame Options	Benefit
PVC	Corner Post	Corner Post	Corner Posts are used to provide hanging options for single and multiple panels within a corner application. Closes light gap for flush mounted hinges. Corner Posts are manufactured according to the size required for each installation. Note: Corner posts are constructed from Basswood not PVC

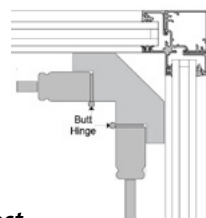

All measurements vary depending on application

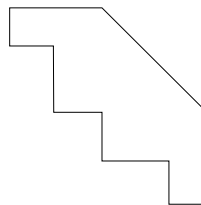

## Bay Window Post

Shutter Type	Type	Frame Options	Benefit
Aluminium	Bay Window Post	Bay Window Post	Bay Corner Posts are used to provide hanging options for single and multiple panels within a bay window application. Closes light gap for flush mounted hinges. Bay Window Posts are manufactured according to the size required for each installation. Note: Bay window posts are constructed from Basswood not PVC

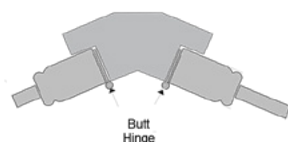

All measurements vary depending on application

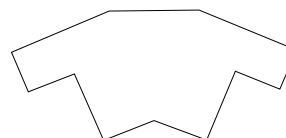

# PVC Shutters

## - Panel types - Hinged, L Frame & T Post Hinged

### Panel Types

Panel Types refers to the variations of each type of shutter: single panel fixed, single panel hinged, bi-folds, L Frame and T Post, straight sliding and bi-fold track variations.

The type of hinge used for a single panel, bi-fold, L Frame and T Post and for Rabbet stiles applications is a Butt hinge. However, if you require your panel to protrude past the window opening, a Steadman hinge is required hinged from a hang strip.

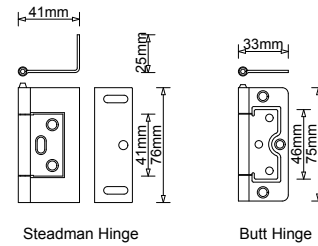

### Hinged

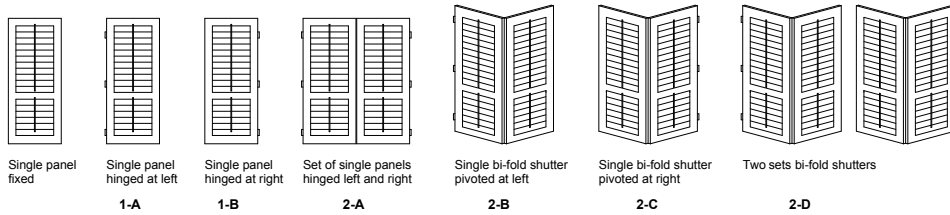

### L Frame and T Post Hinged options

When tracks are not feasible, L frame and T Posts are used to provide options for single and multiple panels within an opening or outside the opening window (see examples below).

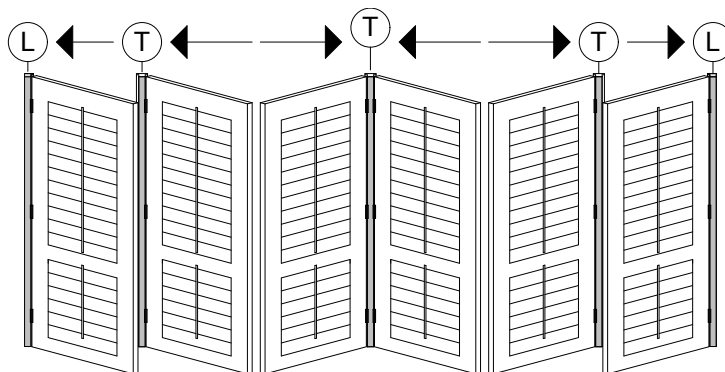
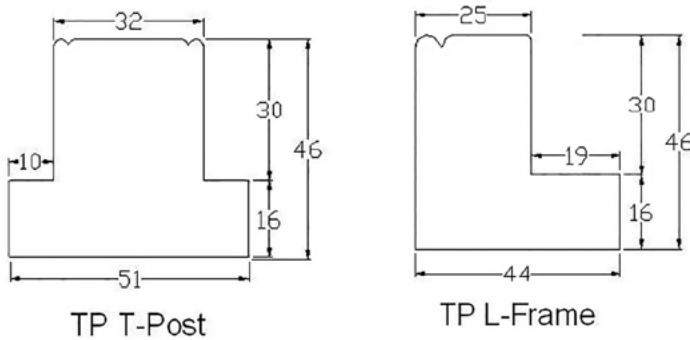

SPECIFICATIONS

# PVC Shutters

## - Panel types - Hinged, L Frame & T Post Hinged - Contd.

### L Frame and T Post Hinged - cont.

#### Key

<b>T</b> means	Panel is hinged from a T Post or closes onto a T Post
<b>L</b> means	Panel is hinged from a L Frame or closes onto a L Frame
means	Panel direction to the right
means	Panel direction to the left

#### One Panel

Variations:



#### Two Panel - Individually Hinged

Variations:

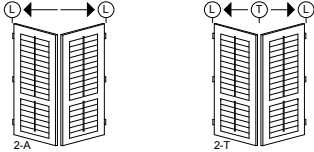

#### Two Panel - Bi-fold

Variations:

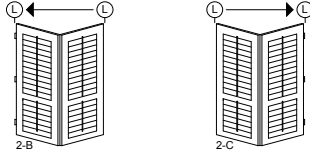

#### Three Panel - Individually Hinged

Variations:

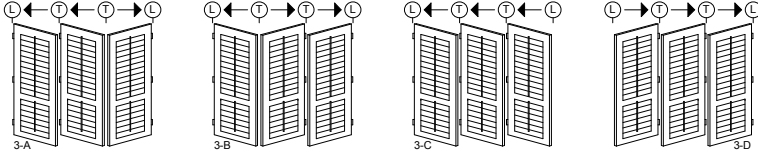

#### Three Panel - Bi-fold

Variations:

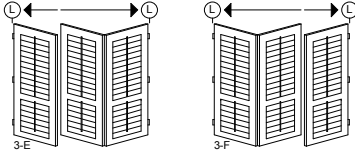

#### Four Panel - Individually Hinged

Variations:

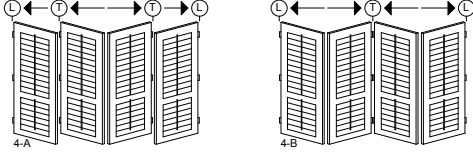

#### Four Panel - Bi-fold

Variations:

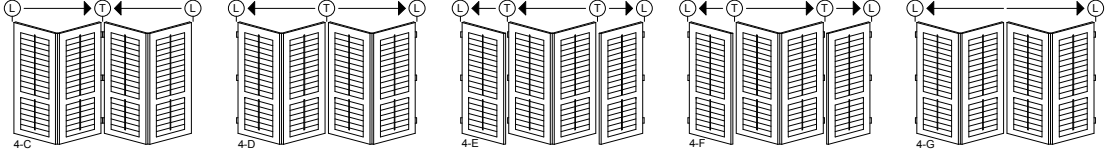

#### Six Panel - Individually Hinged

Variations:

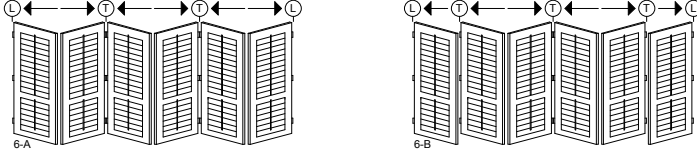

#### Six Panel - Bi-fold

Variations:

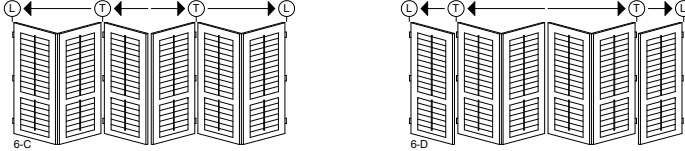

# PVC Shutters

## Fixed Louvre Shutters, Overview specifications

### Fixed Shutters

Fixed louvres are permanently open (ventilated - Type A) or permanently shut (non-ventilated - Type D). Permanently open means that there is always ventilation while blocking line of sight. Fixed louvres may be employed for a variety of reasons: to control the amount of sunlight that enters a room, to provide privacy and security, protect against weather, unwanted intrusion or damage and to enhance the aesthetics of a building.

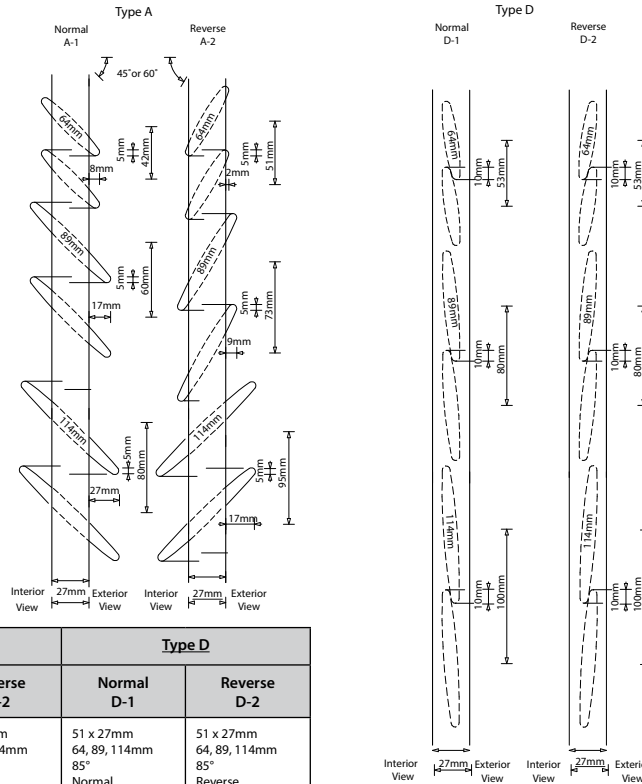

	Type A		Type D	
	Normal A-1	Reverse A-2	Normal D-1	Reverse D-2
Stile (PVC)	51 x 27mm	51 x 27mm	51 x 27mm	51 x 27mm
Louvres (PVC)	64, 89, 114mm	64, 89, 114mm	64, 89, 114mm	64, 89, 114mm
Angles	45° or 60°	45° or 60°	85°	85°
Louvre Facing	Normal	Reverse	Normal	Reverse
Projection (PVC)	8, 17, 27mm	2, 9, 17mm		
Finish (PVC)	Painted	Painted	Painted	Painted

### Overview PVC Shutter Specifications:

<b>Louvre Size</b> <b>Type</b> Louvre - Aerofoil <b>Size</b> 64mm x 11mm 89mm x 12mm 114mm x 12mm <b>Options</b> Half Open, Fixed, Ventilated, Fixed Non-Ventilated	<b>Recess</b> <b>Size</b> 80mm - 150mm <b>Please Note:</b> Varies, depends on Louvre size.
---	--

<b>Finish</b> <b>Type</b> Painted <b>Colours</b> Standard colours: White, Snow, Swiss coffee, Creamy, Butter, Super white, Pearl white, Eggshell, Pearl, Bristle half, Antique white, White on white or Custom Colour
---

<b>Width &amp; Height Hinged</b> <b>Type</b> Maximum Width 750mm (Single Panel) 500mm (Bi-fold Panel) Minimum Width 300mm (Single Panel) Minimum Height 300mm Maximum Height 2400mm Note: Shutters over 1500mm in height will be constructed with a mid-rail	<b>Stile &amp; Rails</b> <b>Type</b> Stile 70mm - 150mm x 20mm 82.6mm x 20mm Shutters over 1500mm 1 mid-rail 70mm - 150mm x 20mm (varies, depends on height of panel) Tilt Rod 15.8mm x 12.5mm Clear view concealed <b>Options</b> Square D-mould Tilt Rod (centered, left, right) Clear View
---	---

<b>Track Systems</b> <b>Type</b> Maximum Width Maximum Height <b>Multi-fold</b> 500mm per Panel (maximum 8 x Panels on each side) 2400mm Note: Shutters over 1500mm in height will be constructed with a mid-rail <b>Single Run</b> 900mm per Panel (maximum 6 x Panels on each track) 2400mm Note: Shutters over 1500mm in height will be constructed with a mid-rail
---

SPECIFICATIONS

# PVC Shutters

## Hardware Technical - Tracking systems, Hinges

### Hardware Overview

#### Tracking Systems

Window Treatments supplies two tracking systems: Multi-fold for bi-fold shutters, and Single Run for straight sliding shutters. For special applications Window Treatments can supply various track options to suit your requirements.

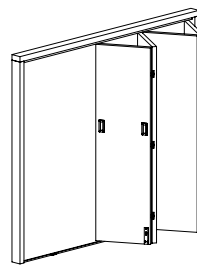

Multi-fold for Bi-fold shutters

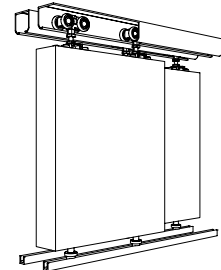

Single Run for straight sliding

#### Hinges

Depending on the type of shutter installation, Butt Hinge and Steadman Hinge are the standard hinges. For special applications, Window Treatments also supplies various hinge options such as Handle hinges to suit your requirements.

#### Butt Hinge

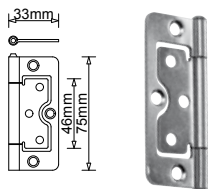

#### Steadman Hinge

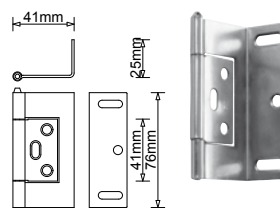

#### Handle Hinge

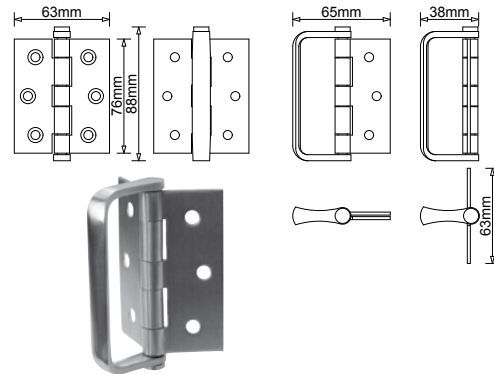

#### Barrel Bolt

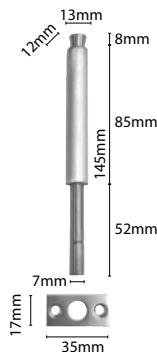

#### Magnetic Catch

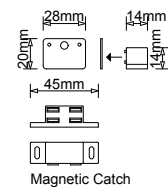

#### Magnetic Catch

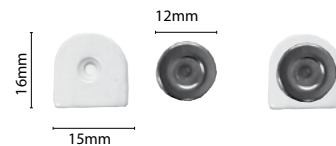

#### Ball Stop

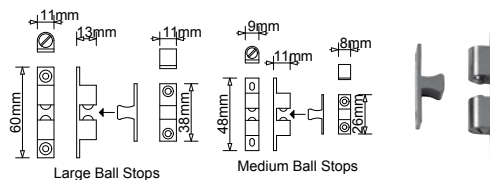

Type	Colours Available	Suitable for
Butt Hinge	Stainless Steel, Silver, Cream, White, Black, Antique Brass, Bright Brass	Square, Rabbit, T Post, L Frame
Steadman Hinge	Stainless Steel, Silver, Cream, White, Black, Antique Brass, Bright Brass	Hang Strip, protruding past window opening
Handle Hinge	Stainless Steel	Bi-fold, assists panel movement
Barrel Bolt	Stainless Steel	Bi-fold, Sliding, Panel
Ball Stops	Brass, Chrome	Securing Fixed Panel
Magnetic Catch	Brown, White, Black	Securing Bi-fold Panel



# PVC Shutters

## - Hardware Technical - Sliding Single Run

### Application

- Widely used in lighter commercial and industrial applications
- To cover any width of opening, any number of panels can be used
- To accommodate different building designs, panels can slide to one or both sides
- Hinged panel for easy access may be incorporated into a sliding panel
- Where panels are fitted externally, a canopy is recommended



### Panel Specification

**Track System: Single Run (individual Panels)**

Max Panel Height: 2400mm

For ease of operation it is recommended that the panel width should not exceed 75% of the panel height.

Panels for interior use can be of flush construction or glazed. Panels for industrial applications should be framed, ledged and braced.

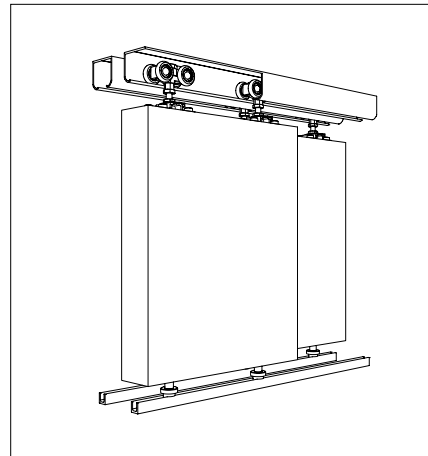

### Hardware Specification

Track : 80A  
 Material : Aluminium  
 Standard lengths : 2000mm, 3000mm, 4000mm, 6000mm  
 Aluminium track available in mill or clear anodised finish.

Door Stop : 20DS (Stainless Steel)

Hangers (2 per door) :  
 Interior : No. 57EN Hamger  
 Hangers supplied with fixing plate and nylon tyred precision bearings. Vertical adjustment is simple and positive. Nylon tyre wheel hangers should not be used on installation involving temperatures exceeding 80°C.

Guide : No. 801S  
 Spring loaded guide, nylon body and tip with stainless steel shaft and spring.  
 Designed to slide in the No. 92 Threshold

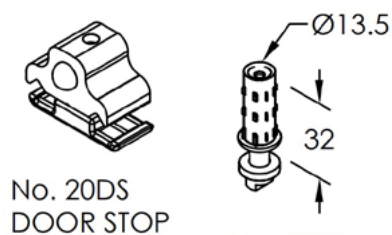

No. 20DS  
DOOR STOP

No. 801S  
GUIDE

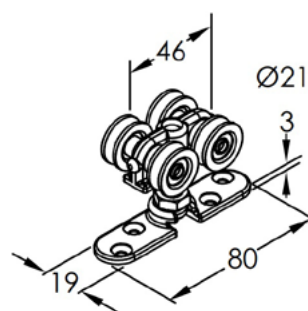

No. 57EN  
HANGER

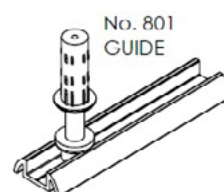

No. 92  
THRESHOLD

SPECIFICATIONS

# PVC Shutters

## - Hardware Technical - Multi-fold

### Application

- Suitable for residential and light commercial folding shutters with all panels of equal width. Panels can fold to one or both sides of the opening
- Pivot hardware enables a folding exterior shutter to be designed using equal width panels with no cutting down of the panel adjacent to the post.
- To cover any width opening, any number of folding units can be used.



### Panel Specification

**Track System: Multi-fold (individual leaves)**

Max Leaf Height: 2400mm

Max Leaf Width: 500mm

Units of up to six panels can be pivoted to each side of the opening.

A guide system across the floor must be used on units of three panels or more. Floating units consist of four to six panels. Shutters should be constructed to provide secure fitting for the pivot sets, hangers, hinges and guides.

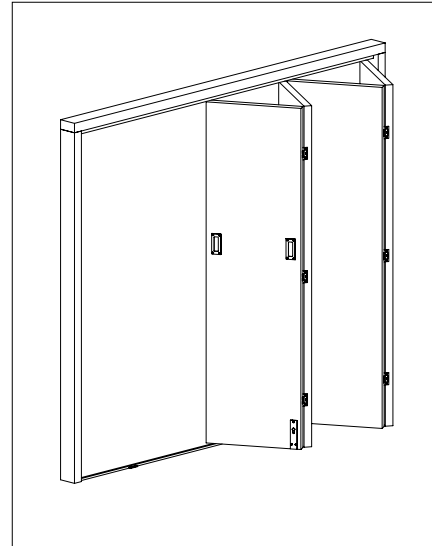

### Hardware Specification

Track - punched for soffit fitting: 80A

Material : Aluminium

Standard lengths : 2000mm, 3000mm, 4000mm, 6000mm

Top Pivot Assembly : 21EPNC Steel, Zinc dichromated, Nylon

Bottom Pivot : 21EPNC Steel, Zinc dichromated, Nylon

Door Stop : 20DS (Stainless Steel)

Hangers : No. 57EN Hanger

The hanger is fitted with four nylon tyred ballrace wheels. The adjustment bolt is attached to the top plate and secured in place with a blocking clip which allows easy installation. All steel parts are zinc dichromated.

Guide : No. 801S

Spring loaded guide for use with No.92 Threshold. Guide is nylon and stainless steel.

Threshold : No. 92

Threshold, aluminium, available in 2100mm, 3000mm, 4000mm, 6000mm

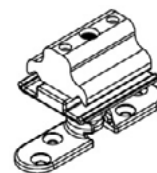

No.21EPNC  
Top Pivot

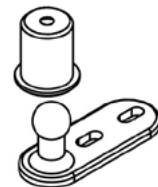

No. 21EPNC  
PIVOT

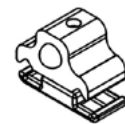

No. 20DS  
DOOR STOP

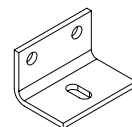

No. ADP1/60 Bracket

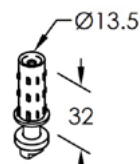

No. 801S  
GUIDE

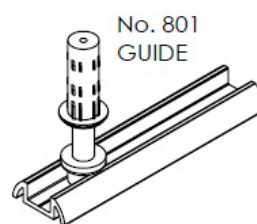

No. 92  
THRESHOLD

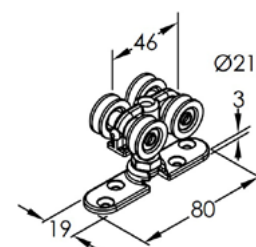

No. 57EN  
HANGER

# Motorised Shutters

A Shutter 12v Motor Upgrade is available and is particularly useful where shutters are installed in "out of reach" places such as skylights and high gable-end windows.

- Shutter motors can also be installed onto existing shutters and on all types (Basswood, PVC, Aluminium & Cedar).
  - The 12v rechargeable battery motor operates the louvre tilt only.
  - Shutter Motors are white
  - Charging of the battery is either by connecting a charger to the detachable battery and or, connecting a solar panel which is fixed onto or close to the glass. *See figure 2 (next page)*
  - The shutters motors are controlled by a 15-channel remote allowing multiple shutters to be controlled with one remote.
- **Rectangular shaped shutters:**
    - o The motor is fitted onto the stile facing the glass, so it is not easily seen from the inside. *See figure 1*
    - o The motor is fitted to the shutter stile on the opposite side to the Clear View Tilt Rod.
    - o The minimum height of the shutter panel to accommodate a Shutter Motor is 400mm
  - **For Raking (sloping) shutters:**
    - o The motor is fitted onto the stile facing the glass so it is not easily seen from the inside. *See figure 1*
    - o The motor can only be fitted to the short side of the panel. The clear View Tilt Rod is always fitted to the long side of the panel. *See figure 1*
    - o The minimum height of the short side of the shutter panel to accommodate a Shutter Motor is 400mm

**Figure 1**

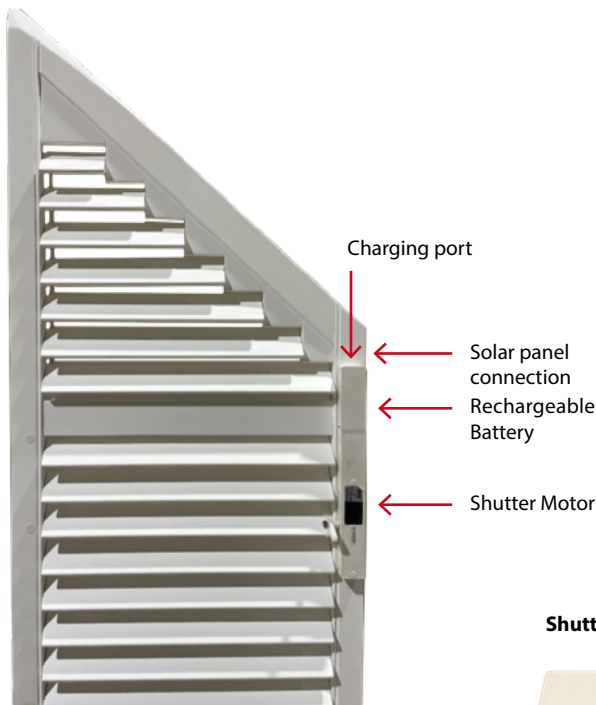

1. The motor and battery are always fitted to the short side of a raking shutter
2. In the example above, the rechargeable battery sits on top of the motor. If the motor is fitted to the opposite side of the shutter, the rechargeable battery sits under the motor

### Shutter Motor AM20 Specifications



Voltage	5VDC
Torque	50N
Speed	8mm/s
Radio Frequency	433.92MHz
IP Level	IP32
Rated Power	2W
Operated Temperature	-10oC - +55oC
Dimensions	210 x 35 x 20
Battery Capacity	Lithium 900mAh
Battery Dimensions	90 x 35 x 20

SPECIFICATIONS

**Figure 2**

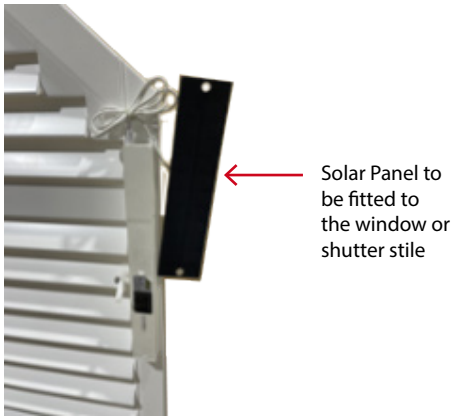

**Solar Panel**



Dimensions	250 x 60 x 12
Cable Length	1m

**Figure 3**



Shutter panels with a Clear view Tilt bar can be joined together if requested to allow one motor to operate a shutter which has a midrail

- Shutter panels with a Clear View tilt bar can be joined together if requested to allow one motor to operate a shutter panel which has a mid-rail. *See figure 3*
- Shutter Panels with a Plantation Tilt Bar cannot be joined so a panel with a mid-rail requires two motors.